



See Ya!
FOUNDER
Edition
Alfa

Luxurious innovative design.

Alfa[™]

Rich in value...



See Ya!
Alfa



See Ya!
Gold

2007

From the desk of Johnnie Crean

For years, our motto was “Alfa Gives you more.” This year, we are changing our motto to answer the question, More What?

Luxurious Innovative Design

We are building a home and a vehicle so you can take your home with you. So livability, durability, and drivability are the design challenges.

At Alfa we define luxury as comfort and convenience. We believe a luxurious design is one that accommodates daily living. So we spend the resources on making your daily living more comfortable and easy. An RV is a small home, and the space utilization needs to be well considered. And each part of our daily life needs special consideration. So we need a great bedroom, bathroom, kitchen, sitting areas, and storage, storage, storage.

As an avid RV user for 50 years, I design the See Yas based on my experience when on the road. Lots of analysis of our use of the See Ya results in the discovery of issues that if solved increase the convenience of daily living in the unit.

Innovative design involves solving the use issues to make daily life easier. We don't design to make it easy to build, we design to make it easy to use. And when there is a livability issue, we jump out of the box to see what should be, not what is currently being done by everyone else. Innovation is driven by looking at what exists,

analyzing the limitations, and innovating to solve them.

Rich in value

The value of an Alfa product is driven from several design philosophies.

Quality is the greatest value, and we achieve higher quality by building fully equipped RVs so our assembly team does each model the same and right. Each model is fully equipped so options don't decrease the build quality, and we achieve great efficiencies from the standardization.

Functional design that simply achieves the goal produces reliability and value. Each design challenge is solved with the simplest and most reliable solution. Durability, quality, and reliability are paramount at Alfa. We don't waste effort and dollars on visual impact, especially when it decreases function and increases cost.

When comparing our See Ya to other coaches, make sure you shop long enough to let the impact of shine and glitz wear off. Do you want to buy something designed to look good, or something designed to live good? In the long run, we believe value is driven by durability, livability, and functionality.

A trip through our brochure will enable you to identify and appreciate luxurious innovative design-rich in value.

Johnnie Crean

Inside:

Letter from Johnnie Crean1

Alfa's History2

Innovative Exclusive Alfa Features . .3 – 10

Standard Features11 – 13

See Ya! Founder14 – 17

See Ya!18 – 22

See Ya! Gold23 – 27

See Ya! & Gold Features28

SeeYa! So Long29

2007 Floorplans30

The XC Chassis31 – 32

2007 Model Specifications33

Warranty34



**Andrew Crean & John Crean head off
for an adventure in their 1920's
Model T Motorhome**



**Johnnie Crean building a
trailer in the 1950's.**



**The Crean Family vacationing in their RV
Circa 1960's.**

*Over 20,000 RV's built in 33 years...
a Lifetime of Experience in every single one.*

ALFA, (A Loving Family Affair) was founded in 1973 by Johnnie Crean, with the help of his father John Crean, the founder of Fleetwood Enterprises.

Since 1973, Johnnie has built over 20,000 RV's.

Apparently, what he learned from his apprenticeship with his father suited him very well. I guess that it didn't hurt that he'd grown up around RV's, as did his father before him. We design and build RV's according to a lifetime of experience, so that your family will have a lifetime of precious memories.



**The next generation of Creans
enjoying the RV lifestyle!**

Luxurious innovative design
Alfa
Rich in value...

Making an RV Feel Like a Home

An RV is limited in space, and the challenge is to make a small house seem big. A design feature is the avoidance of cabin fever. Our innovative design solutions make an Alfa feel like a HOME.

- If a house is small, having high ceilings makes it feel bigger. In fact, a common design feature of more expensive homes is high ceilings. Alfas have the highest ceilings. Another feature of expensive homes is big windows. Any space seems bigger if it has a view, and the view out of an Alfa is unsurpassed. With higher ceilings and bigger windows, Alfa makes your RV feel like a home.
- An RV has logical height limits. If you want a taller interior, the solution is to take the air conditioners off the roof. Our main body interior headroom is 90 inches, without excessive exterior height, because we have basement air.
- The extra height in the main body is critical because it enables us to make the slide outs taller so you can walk in them, and so the tops of the windows can be higher. Your home feels better if, when standing, you are looking out the window at the surroundings instead of at a cabinet or wall 24 inches from your face.

Windows don't insulate as well as walls, so if you want to have a home with a view, the issue needs to be addressed. Alfas have thicker walls, rated at R11 instead of the industry standard of R7, for a 40% increase in thermal efficiency.

Air conditioning is best if the duct is bigger. Radiant heat beats on the roof, and the thicker the insulation, the more effective it is. Roof A/C units have roof ducts, and the ducts are smaller, inhibiting distribution. Roof ducts decrease the effectiveness of roof insulating value, and they aren't insulated well, thus enabling the radiant sun to sap the cool from the duct before the air gets to the interior. Basement air is thus clearly more efficient and effective than roof air.

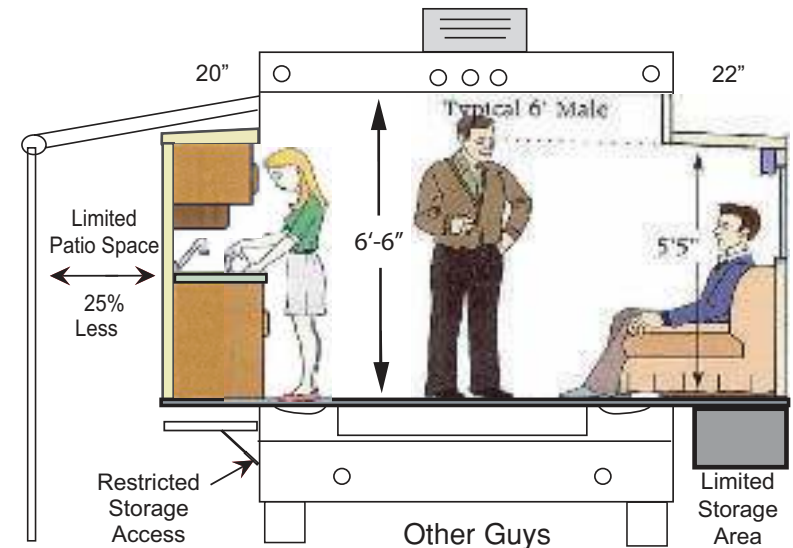
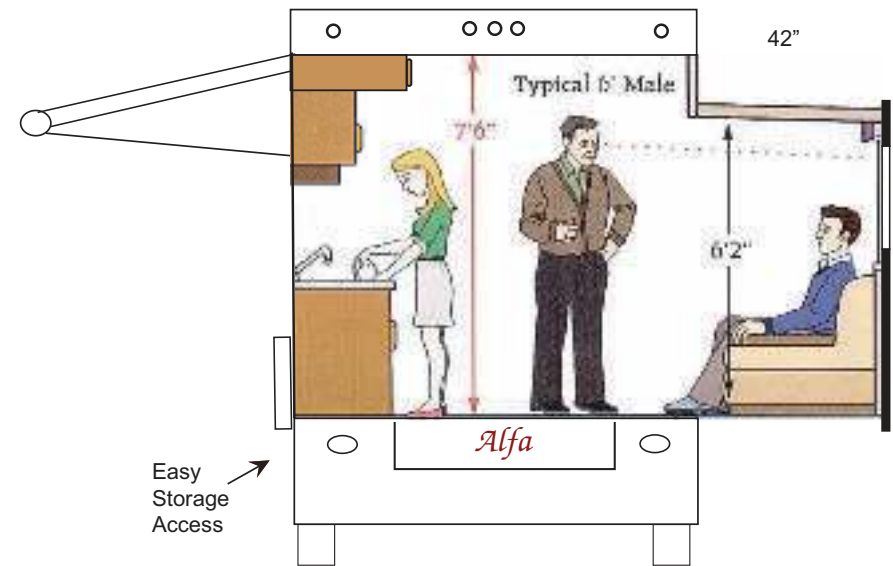

Alfa's design ensures that the patio is part of your home...

Alfas are designed for those who use their RV's on a frequent basis. Considering that a lot of the time spent in an RV is outside in the patio, we've made sure that your livability is enhanced in the patio area. While those "other RV companies" take room out of your patio by sticking opposing slides on the coach, directly cutting into your patio area, we believe that a single road slide is the best solution for livability.

Alfa's single main slide-out room is up to 42" deep, giving you the livability of two slide-outs without the patio interference that two opposing slide-outs cause.

A single slide-out also leaves the basement storage compartments easily accessible without the slide-out room above them.

In an Alfa, the patio side of the coach is preserved for storage of items used on a daily basis, such as the BBQ, chairs, sporting gear, pet supplies, or whatever you normally store in the patio compartments.

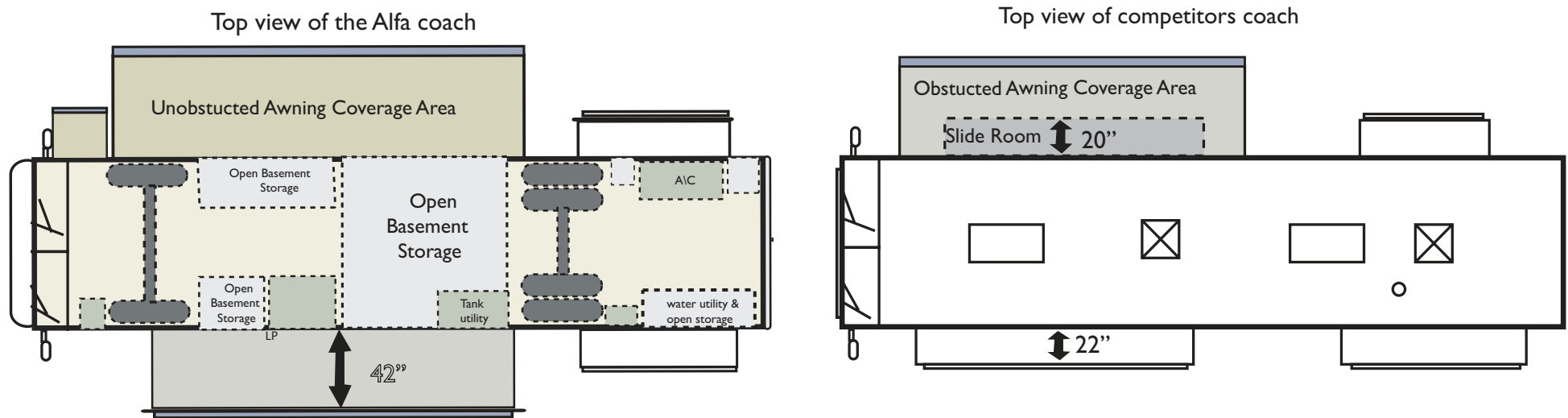

THE DISADVANTAGES OF DOUBLE LIVINGROOM SLIDE-OUT ROOMS

Patio side slide takes up 20" of awning coverage and decreases access to actual storage.

Obstructed access to basement storage compartments

Patio slide unit cuts into patio limiting livability.

Bedroom Suite, or Trip, Squeeze and Shuffle?

The industry standard is to put the wardrobe at the rear of the coach, and to locate the bed between the wardrobe and the rest of the unit. The floor between the bed and the wardrobe has to be higher so there is always a step up to this area. Then the bed is between you and your clothes, it means you always have to go around the bed and up the step to get to the closet or into bed. If the bed is stuck in a slide out, its harder to get into and out of bed because you can't just sit in the bed where you need so you can just rotate your body and lay your head on the pillow. Finally, making a bed stuck in a slide out with two narrow aisles and a step up area is a pain in the neck.



Alfa's Innovative Design 40' See Ya!

1. It's easier to make the bed with access and a flat floor
2. Getting into bed is easier in an Alfa! If you can't sit on the edge of the bed, you have to crawl into bed and wake your partner.
3. Wider aisles make it easier when getting out of bed in the dark

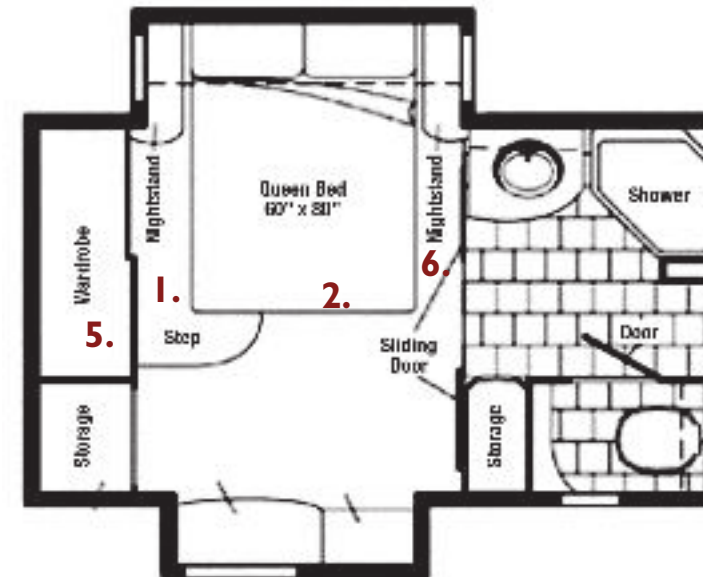

The Industry Standard Bedroom

4. Wardrobe is more adjacent to the bath area, and access is on a flat floor with lots of room for access
5. To access wardrobe, you must walk around the bed, and mess with an inconvenient step
6. Is this tight enough?

The Perimeter Frame

The perimeter frame is made using 6-3/8" steel angle with C-channel welded inside.

2" x 2" box tube is welded from side to side in the perimeter frame.

3 1/2" Z-bar is welded running front to back on top of the box tube.

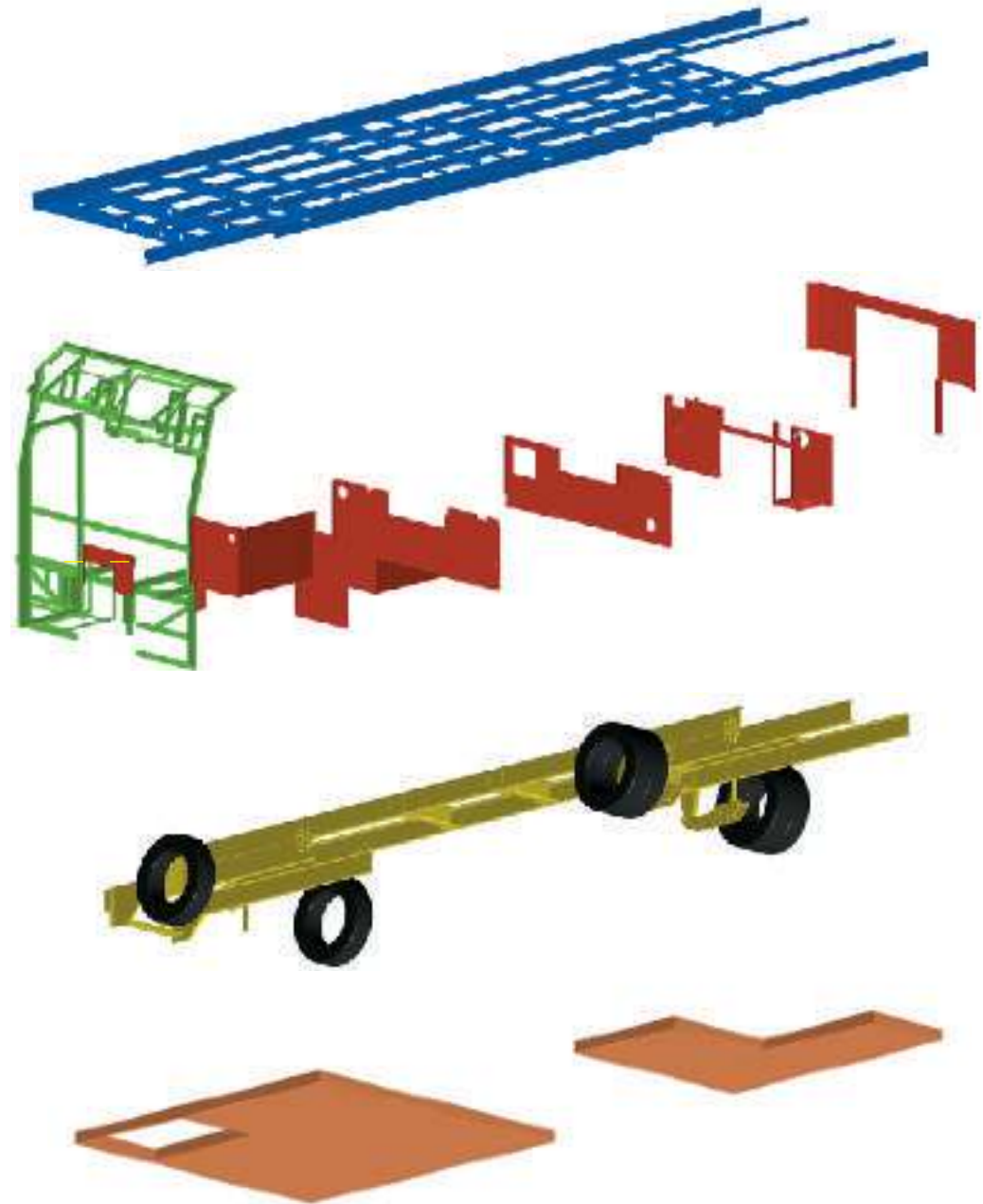

Bulkheads are welded from front to back of frame, 2 above the frame floor, and 3 below.

The frame is lowered over the Freightliner chassis with the bulkheads running along both sides.

The bulkheads are completed with steel members welded below the chassis rails, so the bulkheads completely surround the chassis.

3" thick, steel framed, foam filled, vacuum bonded basement floor is then welded to bottom of bulkheads.

Lock-Box Chassis / Frame Technology

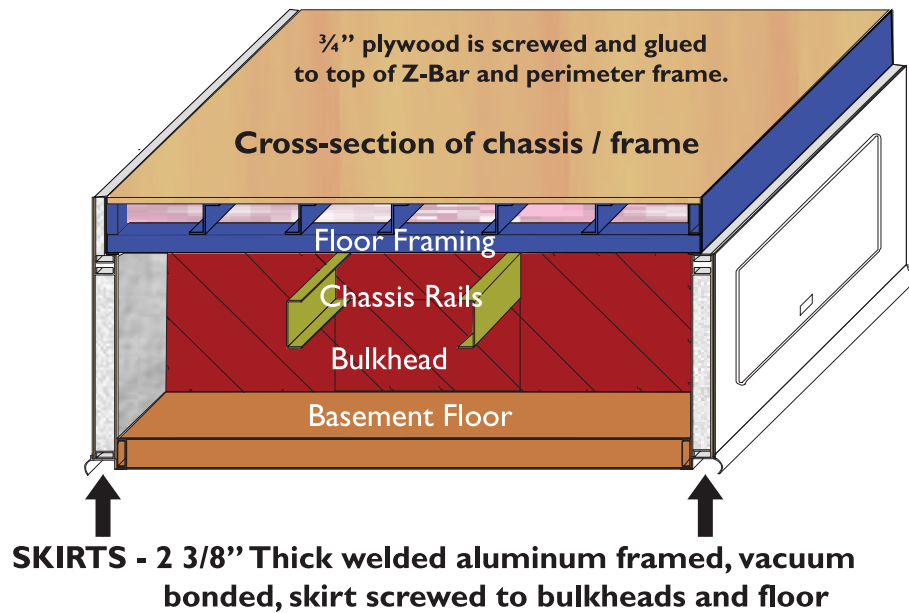

A Quiet Ride

The 6 3/8" floor structure, combined with the 3" structure at the bottom of the exterior storage areas between the wheels, plus the front bulkhead, blocks more road noise than the industry standard 2-inch floor and very thin trunk bottom. Drive an Alfa and anything else, and you will hear the difference. It's nice to be able to just talk and not have to yell.

A Concrete Like Floor

While the industry standard is a floor surface on a 2" frame, Alfa's steel frame is 6 3/8" thick. Jump on any other coach floor, then jump on an Alfa's coach floor. You'll feel the difference! When standing in another motor home, you can feel the floor flex when someone walks by you. Even when sleeping, you sense the flexing floor and the movement transmitted throughout the coach. Our solid floor promotes a secure feeling.



Drives Better - It's Quieter - And the Floor is Like Concrete

As a direct result of the See Ya's Lock Box design, coupled with our 2 3/8" thick walls, and one piece composite roof the Alfa is the strongest coach on the road today. This strong coachwork set atop the industry leading Lock Box Chassis / Freightliner Technology gives you the best drive and quietest ride in the diesel market.

Better Cooling

More effective cooling air moves best through big ducts, and it moves best if the run is straight. Our 6 3/8" floor structure gives us room for a duct up to twice as thick as other ducts, and the run is straight.

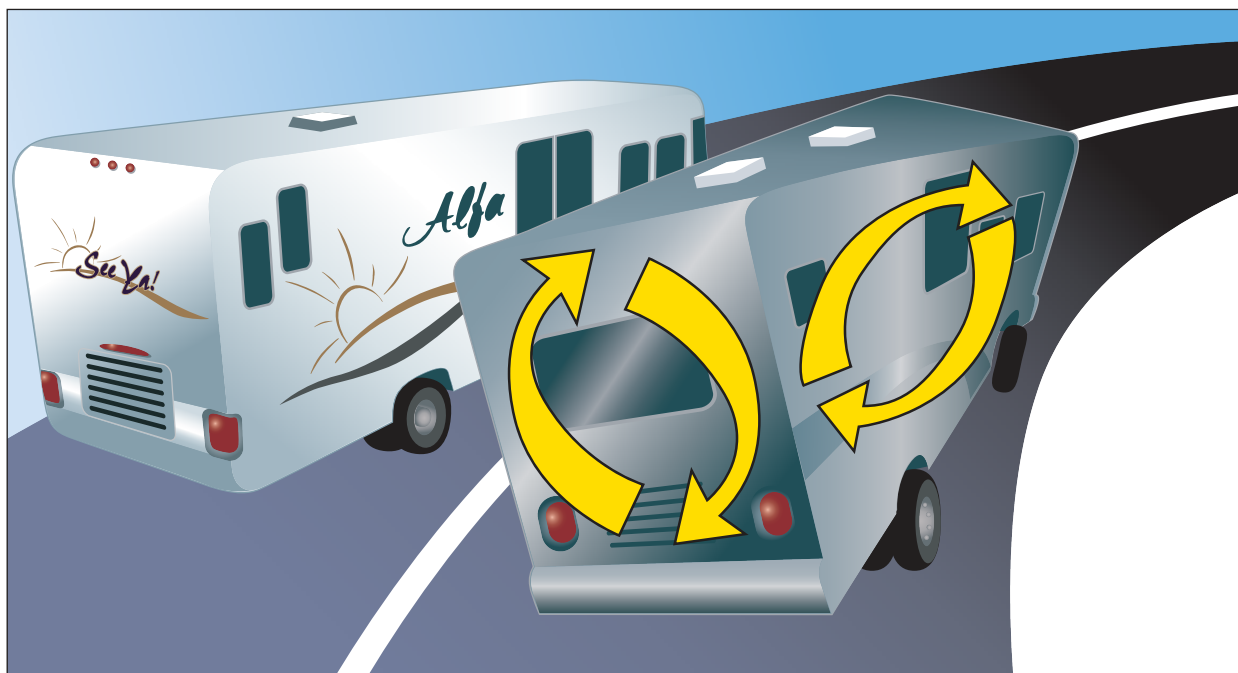

Less Noise

This exclusive design reduces roof noise, provides a vault-like basement, and a floor so strong it reduces twisting, flexing and bump steer.

A Great Drive

Alfas drive better because of superior torsional rigidity. Bump steer is when the twisting and flexing ladder chassis changes the relationship of the axles to each other, which steers the coach. Our Lock Box significantly reduces this movement. Driving is a complex and tiring job, and less bump steer makes an Alfa easier to drive. Bumps don't cause the coach to steer itself this way and that as much, and it makes driving less tiring.

Efficient Air Conditioning & Thermally Developed Motor Home

The Solution is Basement Air.

Heat comes from the sun, and it comes in a radiant form, mostly on the roof. The best insulation is thickness. The thicker something which insulates is, the better it insulates. So a thick roof with no duct in it is best.

RII Walls are 40% more protection than the industry standard walls.

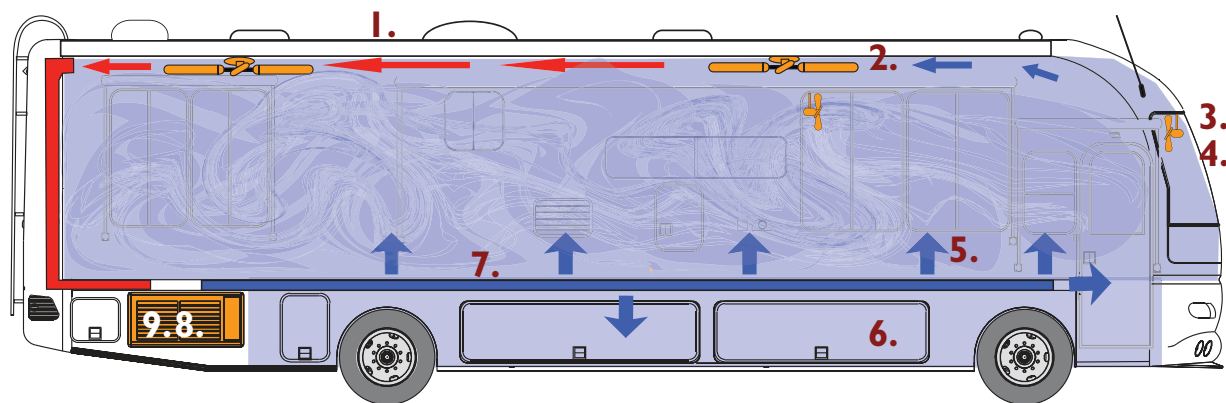

1. Insulate - Our thick roof provides solid insulation and no ducts in the roof make it 20% more effective.

2. Circulate - Two ceiling fans help circulate the air, allowing you to get cooler, faster!

3. Protect - Snap on shades clips over the windshield to block the sun's rays while still allowing a view.

4. Isolate - For extreme conditions, electric shades covering the windshield can be used to create an insulation barrier of dead air.

5. Stack It Up! - As the A/C pushes out cold air, the air stacks within the coach.

6. Direct the Air! - Three fans direct a cool breeze to where you need it.

7. Let It Flow! - Installing the duct in the floor enable a substantially bigger duct than any roof duct, because there is more room in the floor. The bigger the duct the better. Ours is biggest.

8. Smarter Placement - A/C unit is placed next to the large air duct, allowing for direct air flow.

9. Strong Choice - Because our unit is mounted to a steel chassis, instead of placed on the roof, the A/C unit limits the amount of vibration, giving you a quieter coach. The other manufacturers' design their coaches with A/C mounted to the roof, which makes you feel as if you are living inside of a drum!

Alfas are distinctly more livable than our competitors!

Great Galley Luxuries!

Deep Galley provides a place for your toaster and coffee pot, right on the countertop!

Only Alfa gives you attic storage! Instead of a slide-out flange in the way, we give you what you really need - more room for your stuff!

21" oven with 3 burner range & self lighting high output burners

Water filter with faucet

Exclusive Interior/Exterior Trash can allows you to remove the waste from the outside, so the interior of your coach remains neat and tidy!

Fantastic Living!

Tall ceilings - 7'6", with 6'2" interior headroom in slide out giving you a coach that feels more like home!

Large windows for great visibility, natural light and cross ventilation

Solar tinted glass help keep the heat out while letting the sunshine in!

Fishing Rod Storage gives you an up and out of the way compartment for your poles.

Standard Features For All Models

Electrical Systems – 7.5 KW Diesel Generator • 2000 Watt Xantrex Inverter W/ 100 AMP Charge • Eight Batteries: 6 Six Volt, 2 Twelve Volt • 160 AMP Alternator • 50 AMP 120V / 240V Power Distribution Panel • Hard-wired Power Cord 28 Ft 50 AMP • Battery Disconnect Switches • Systems Monitor Panel • Interior Located Fuses for Convenient Easy Replacement

Drivers Cockpit – Four-Point Fully-Automatic Electric Leveling Jacks • Power Steering / Cruise Control • Tilt & Telescopic Steering Wheel Column • Back Up Camera with Monitor and One Way Speaker • Power Controlled Heated Exterior Mirrors • Dash Fans • Pilot and Copilot Lights • 12V Outlet • Rear View Mirror for Interior Viewing

Air Conditioning – 27,000 BTU Residential Style Basement Air Conditioning System with Heat Pump • Dual Pane Windows • Electronic Controlled Dash Heating and A/C System with Defroster • 35,000 BTU Furnace • In-floor Ducted Heating and Air Distribution System • Fan-tastic™ Fan In Living Room and Bathroom • Deluxe Ceiling Fan in Livingroom and Bedroom

Interior Luxuries & Entertainment Systems – Roof Mounted Automatic Satellite Dish with Dual LNB • Oak Cabinet Doors Throughout • Sleeper Sofa • Soft Touch Carpeted Ceiling • 27” Overhead TV • 20” Flat Panel TV in Bedroom • In Dash Stereo System with CD Player and Sirius Satellite Radio • Entertainment Center with Combo VCR / DVD Player • Four Living Room, Two Bedroom and Two Basement Speakers

Galley Amenities – Norcold Refrigerator / Freezer with Ice Maker • 21” Oven with 3 Burner Range and Self Lighting High Output Burners • Space Saver Convection Microwave • Solid Surface Countertop with Stainless Steel Sink • Exclusive Interior/Exterior Pass Through Waste Basket System • Oak Dinette Table • Demand Water System with Pump • Deluxe Single Lever Kitchen Faucet with Pull Out Sprayer • Water Filter with Faucet • Counter Flush Knife Rack Behind Stove • Oak Paper Towel Holder with Travel Lock

Features - Above the Industry Standard



In dash Stereo System with CD player & Sirius Satellite Radio – with 100's of channels to listen to no matter where your travels take you.



Auto-Locating Satellite Dish – automatically finds the satellite!



20" LCD in Bedroom – is mounted on swivel brackets to provide convenience while also saving space!



Backup Monitor – and camera for safer travels on the road.



Fully Automatic – One touch Atwood Electric Leveling Jacks



Entertainment center featuring a large 27" TV with DVD/CD player – in a specially made overhead cabinet, so it's out of the way when not in use!

Features - Standard in all Alfas



Fan-Tastic™ Fans – in both Living room and Bathroom. Keep your coach cool and ventilated with constantly circulating air.



7.5 kw Diesel Generator – Safe and effective way to get power for your appliances when you're on the road and can't plug in.



Ceiling Fans – located in the livingroom and bedroom for great circulation and a cooling breeze.



A Large Convection Oven/Microwave – for faster and simpler cooking.



Large Norcold 12 cu ft. Refrigerator/Freezer – with an automatic ice maker.

The Founder goes way above the standard features of the common RV. It's all here in your Alfa Founder

Innovation With a View



Model 1009 Shown

Your 2007 Alfa Founder is ready to hit the open road! So much more than what other standard RV's have to offer!

Features Featured Founder



One touch automatic electric awning – with remote and a 3 speed wind sensor, for simple operation and a shady patio.



DVD/VCR combo – to watch and enjoy all of your favorite movies.



Separate radio / CD player – in bedroom with 2 speakers and volume control for private listening.

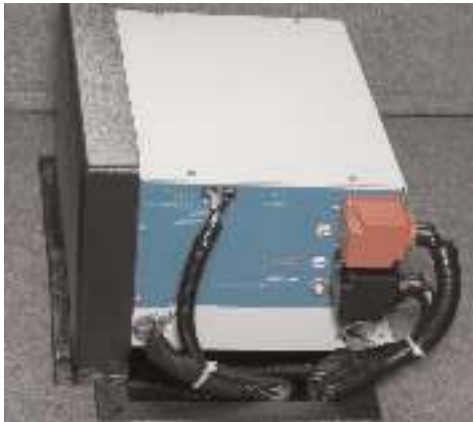

2000 Watt inverter with 100 amp charge – converts DC power into conventional AC power for operation without generator or plug into a park outlet!



Large wardrobe – which can be a hallway to the bedroom, or close the doors and make it a private dressing area.



Folding card table and reclining euro chair – with footstool.



Large galley cabinets – for additional storage, and deep counter space for your toaster and coffee pot.

Founder Engine Specifications

Models 1009

Engine: 300HP 5.9 L diesel Cummins® ISB, 600 lb.-ft torque
Turbo exhaust engine brake

Transmission: Allison® 2,500MH, 5-speed automatic with lock-up, push-button shifting

Vehicle weight ratings:

Front GAWR: 10,500 lb.

Rear GAWR: 19,000 lb.

GVWR: 29,500 lb.

Towing: 3,500 lb.

GCWR: 33,000 lb.

Wheebase: 228" - 35'

Front axle: AF 10-5, 10,500 lb.

Rear axle: ARS-19 : 19,000 lb. 4.78:1

Front Brakes: 15" x 4" Drum-style front brakes

Battery: two 1520 CCA @ 0°F, maintenance-free

Fuel Tank: 90 gal.

Steering system: TRW® TAS-60 integral hydraulic power gear

Rating: 10,500 lb.

Wheel cut: 55-degree

Steering wheel: 18" VIP

Tires: Goodyear 22.5"

Wheels: Steel, 10 bolt lugs, 11.25" diameter bolt center



**Cummins® ISB,
300HP Diesel**

Founder Decors

Fabrics

Fall



Sofa

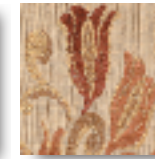

Valances/Dinette



Valances

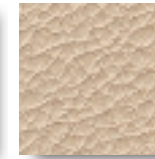

Eurochair

Meadow



Sofa



Valances/Sofa



Dinette

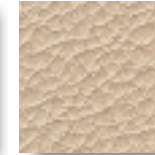

Eurochair

Metro

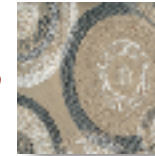

Sofa

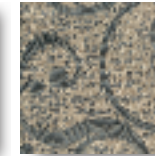

Valances/Dinette

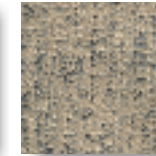

Valances

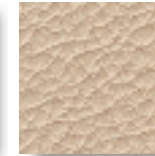

Eurochair

Carpets



Light



Dark

Bedroom Fabrics

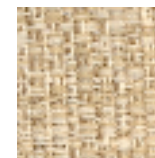

Headboard/Valance

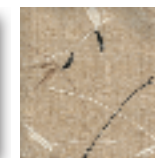

Bedspread

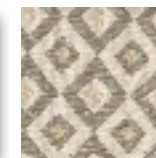

Shams/Valances

Founder Engine Specifications

Models 1010, 1011, 1012 / Option 1009

Engine: 300HP 7.2 L diesel Caterpillar® C7, 860 lb.-ft torque
Turbo exhaust engine brake

Transmission: Allison® 3,000MH, 6-speed automatic with lock-up, push-button shifting

Vehicle weight ratings:

Front GAWR: 10,500 lb.

Rear GAWR: 19,000 lb.

GVWR: 29,500 lb.

Towing: 10,000 lb.

GCWR: 39,500 lb.

Wheelbase: 228" - 35' / 252" - 37'-40'

Front axle: AF 10-5, 10,500 lb.

Rear axle: ARS-19 : 19,000 lb. 4.78:1

Front Brakes: 15" x 4" Drum-style front brakes

Battery: Two 1520 CCA @ 0°F, maintenance-free

Fuel Tank: 90 gal.

Steering system: TRW® TAS-60 integral hydraulic power gear

Rating: 10,500 lb.

Wheel cut: 55-degree

Steering wheel: 18" VIP

Tires: Goodyear 22.5"

Wheels: Steel, 10 bolt lugs, 11.25" diameter bolt center

Luxurious innovative design,

Alfatm

Rich in value...



**Caterpillar® C7,
300HP Diesel**

**You can get this in
your 1009 Founder!**

See Ya!

FOUNDER Edition

By Alfa

A Gourmet Worthy Galley In Your See Ya!



Live your life to the fullest in your 2007 See Ya! The gorgeous interior decor will take your breath away, and the soft leather furniture and comfortable setting will cause you to forget that you ever left home. Sit back, grab a cup of coffee, and watch a movie on your large living room TV! It's the Alfa standard of living!

Luxury & Great Design



Manual window awning on Galley Dinette Slide



Ceramic Tile Flooring – more durable than linoleum, and looks more sophisticated as well.



Oak Dinette Table with Leaf – gives you more seating area when you need it!

Norcold 4-Door, 12 cu ft. Refrigerator/Freezer – allows you more room and easier accessibility to your goodies!

The Alfa Standard for Entertainment...See Ya!



Patio Features:

- **20" LCD TV** with Swivel Bracket • **Weber BBQ** with Easy Folding Stand • **Four Folding Chairs**, Comfortable and Easy Folding • **Two Folding Tables** Provide Space for Your Drink or Food, and is Also Great for Casual Outdoor Card Games!
- **Two Ground Mats** Keep the Dirt Off Your Shoes and Out of Your Coach!

See Ya! The Alfa Standard!



Blackbird GPS – is lightweight, removable, touch screen operated, pre-loaded with 6 million points of interest, and includes maps of the U.S. and Canada!



Smartwheel – puts your driving controls at your fingertips - windshield wipers, headlamps, cruise control and more!



Large 27" Flat Screen TV with Direct TV in Living room – allows you to watch numerous movies, sporting events, local channels and more in the comfort of your RV!



Extension Cord Storage Door – utilizes the thick storage door to keep your extension cords neatly wrapped and easily accessible. Gone are the days of struggling with untying knots from your cords!



50 Amp Surge Protector – keeps your coach protected from the shoddy wiring that exists in most RV parks.



Fan-Tastic Fans – in both Living Room, Bedroom & Bathroom keep the coach cool and ventilated with constantly circulating air.

See Ya! Engine Specifications

Models 1004 and 1007 / Option for 1010, 1011, 1012

Engine: 330HP 7.2 L diesel Mercedes-Benz MBE 926, 1,000 lb.-ft torque
Turbo exhaust engine brake

Transmission: Allison® 3,000MH, 6-speed automatic with lock-up, push-button shifting

Vehicle weight ratings:

Front GAWR: 12,000 lb.

Rear GAWR: 20,000 lb.

GVWR: 32,000 lb.

Towing: 10,000 lb.

GCWR: 42,000 lb.

Wheebase: 252" - 40'

Front axle: I-Beam, Wide track, 12,000 lb.

Rear axle: ARS-20 : 20,000 lb. 4.78:1

Front Brakes: 15" x 4" Drum-style front brakes

Battery: two 1520 CCA @ 0°F, maintenance-free

Fuel Tank: 100 gal.

Steering system: TRW® THP-60 integral hydraulic power gear

Rating: 12,000 lb.

Wheel cut: 55-degree

Steering wheel: 18" VIP Smart wheel

Tires: Goodyear 22.5"

Wheels: Steel, 10 bolt lugs, 11.25" diameter bolt center



**Mercedes-Benz®
MBE 926
Electronic Diesel**

You can get this engine & chassis in your 1010, 1011 & 1012 Founder!

See Ya! Decors

Fabrics

Summer Wind

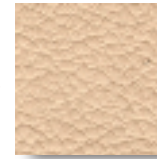

Sofa



Valances/Dinette



Valances

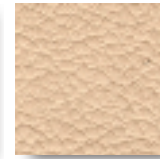

Eurochair

First Snow

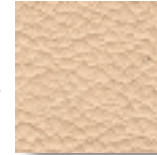

Sofa



Valances/Dinette

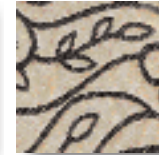

Valances

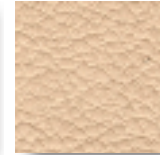

Eurochair

Tuscany



Sofa

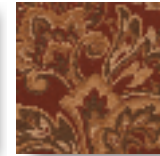

Valances



Valances



Eurochair

Carpets



Light



Dark

Bedroom Fabrics

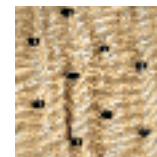

Headboard/Valance



Bedspread



Shams/Valances

See Ya!
Gold

Innovation & Splendor



Only the See Ya Gold could boast this type of luxury. Cutting edge gadgets, beautiful textiles, supple ultra leather furniture, spacious living space, tons of storage, and so much more! It's the Gold standard.

More is always standard in your See Ya! GOLD



In-Motion Tracking Roof Mounted Satellite Dish with Dual LNB - finds the satellite automatically, even when the coach is in motion!



Satellite Receiver and Dish PVR - in living room and bedroom, records up to 100 hours of TV programs!



An even surface - This stove cover provides additional countertop space for food preparation, and also conveniently hides away when using the burners!



Power Cord Reel & Power Hose Reel - help keep your hose and cord tidy and save your hands from getting filthy!



50 ft. Air Compressor - fills your tires, inflates sports balls, and river floating devices!

The GOLD's luxurious amenities in both galley and bath!



Dometic 14 cu ft. Side by Side Refrigerator / Freezer - with automatic ice maker and stainless steel door panels.



Sealed Three Burner Stove - is easy to clean, and 21 inch oven provides ample room for unleashing your inner gourmet!



Solid Surface Countertops - with stainless steel sinks and upgraded faucets and fixtures give a nice and luxurious home feeling.



European Style Body Care Dispenser - holds shampoo, conditioner and body wash for less clutter and mess in the shower!



Garbage Disposal - you don't have to dump the little sink basket.



Heated Ceramic Floor Tiles - in both galley and bathroom keep your feet warm in cool weather! 25

Gold Engine Specifications

Models 1002 and 1008 / Option for 1004 and 1007

- Engine:** **400HP** 8.9 L diesel **Cummins ISL400**, 1,200 lb-ft torque
C-Brake from Jacobs engine brake
- Transmission:** Allison[®] 3,000MH, 6-speed automatic with lock-up, push-button shifting

Vehicle weight ratings:

- | | |
|---|--|
| Front GAWR: 14,320 lb. | Battery: two 1900 CCA @ 0°F, maintenance-free |
| Rear GAWR: 20,000 lb. | Fuel Tank: 150 gal. |
| GVWR: 34,320 lb. | Steering system: ZF [®] 8018 integral hydraulic power gear |
| Towing: 10,000 lb. | Rating: 14,600 lb. |
| GCWR: 44,320 lb. | Wheel cut: 56-degree |
| Wheebase: 252" - 40' | Steering wheel: 18" VIP Smart wheel |
| Front axle: ZF - IFS, 14,600 lb. | Tires: Michelin XZA 3 275/80R22.5LRH |
| Rear axle: ARS-20 : 20,000 lb. 4.63:1 | Wheels: 4 Aluminum, 10 bolt lugs, 11.25" diameter bolt center |
| Front Brakes: Full air 17" disc front brakes
Full air 16.5" x 7" drum rear brakes | |

Gold Decors

Fabrics



Leather Chairs/Sofa

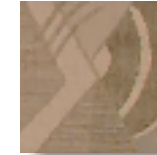

Livingroom/Valances



Dinette/Valance

Carpet



Ceramic Tile

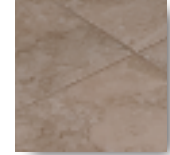

Bedroom Fabric

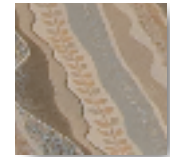

Bedroom Suite

Cummins[®] ISL400 Electronic Diesel

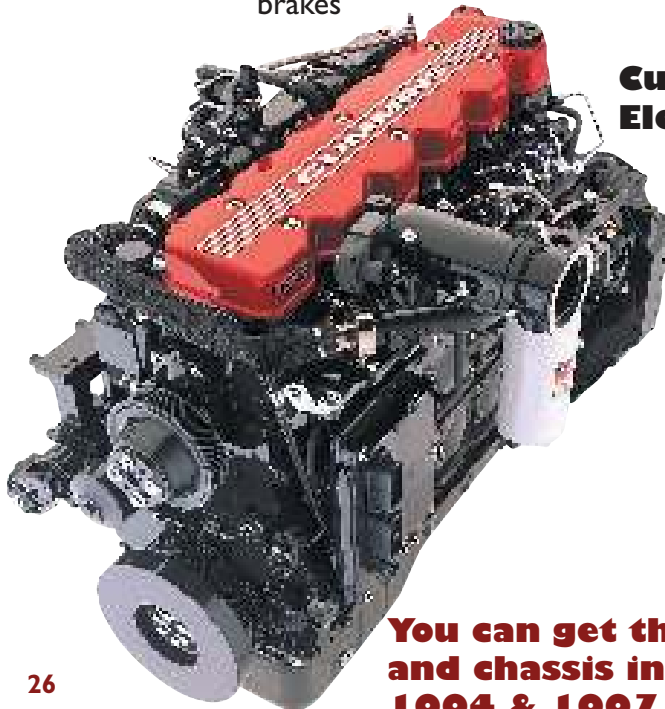

Adjustable Foot Pedals

ZF[™] Independent Front Suspension

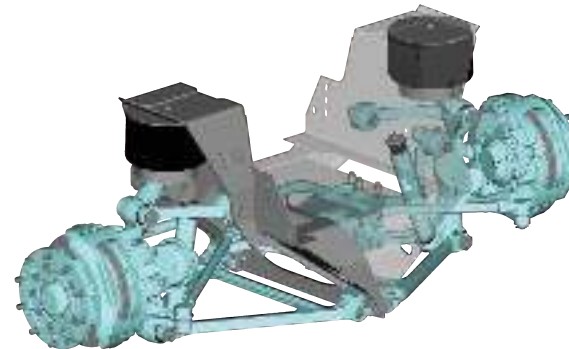

Air Disc Brakes With ABS

You can get this engine and chassis in your 1004 & 1007 See Ya!

The See Ya! GOLD, provides the best in...



- **Near Silent Heating Luxury**
- **Unlimited Hot Water**
- **Heated Tile Floor**

Benefits of this efficient heating/hot water unit include:

Whisper quiet. This heater does not disturb you when you're sleeping or watching TV! The system cycle is nearly silent. Conventional Furnaces are so noisy, and the cycles are maddening.

Endless supply of hot water on demand. You never again have to take a cold shower, or unknowingly wash clothes with cold water.

Silent radiant heat for moderate needs. In moderately cold temperatures, the unit will heat the floor tiles, which then heat the entire coach. A totally silent European type of radiant heat system.

Thermostat in both living room and bedroom. Enables zone heating for personal comfort, and propane saving energy efficiency.

Propane fueled. There is no distinguishing smell of diesel. Plus clean burning propane eliminates the need for yearly maintenance service schedules that diesel powered units require.

5 times more efficient than typical gas and electric tank type RV water heaters!

Plus you have two hot water systems and two heating systems for fail safe security. The Alfa Gold also has a conventional heater and water heater for back up.

See Ya! & Gold Features

See Ya Features

Electrical Systems – 36' 50 AMP shore power cord • Electric Sewer Valves • 50 AMP Surge Protector

Drivers Cockpit – Integrated Leather Driver / Passenger Seats • Ceramic Tile From entryway to Bathroom • Smartwheel • Dual Electric Front Windshield Sun Visors • CB Ready With Antenna

Air Conditioning – Fan-tastic™ Exhaust Vent In Bathroom • Fan-tastic™ Fan In Living Room & Bedroom

Entertainment System – 27" Overhead Flat Screen TV • 20" Patio TV • 20" LCD Bedroom TV • 13" Galley TV • Kingdome with Dual LNB • Satellite Receiver In Front Overhead - Direct TV • 6 Disc CD Changer • 4 Channel Stereo Amplifier • Preprogrammed Universal Remote Control • Four Living Room, Two Bedroom & Two Basement Speakers with 3 Volume Controls

Furniture – All Leather Sofa and Recliner with optional J-Lounge

Gold Features

Electrical Systems – Electric 50 AMP Cord Reel, Electric Hose Reel

Drivers Cockpit – Optima Leather™ Driver / Passenger Seats • Electric Driver & Passenger Side Sun Visor • Adjustable Foot Pedals

Entertainment Systems – In-Motion Tracking Roof Mounted Satellite Dish with Dual LNB • Dual Tuner Receivers / DishPVR in Front Overhead • Up to 100 Hours of Recording Space

Interior Luxuries – Twin Temp Heating System with Continuous Hot Water and Heated Tile for Radiant Heat • Optima Leather™ Recliner • Optional J-Lounge

Galley Amenities – 14 CF Side-by-Side Refrigerator/Freezer with Ice Maker • Brushed Stainless Steel Refrigerator Door Panels • Heated Ceramic Tile with Decorative Accents in Galley and Bath • Deluxe Convection Microwave Oven • Oak Dinette Table with Leaf

Cabinet Construction – Solid Oak Face Frame Throughout • Arched Raised Panel Oak Doors

Luxury & Great Design

The So Long makes an RV like a house, with a **SEPARATE BATHROOM** and a **HALLWAY** connecting the bedroom and the living area. It only takes a day in a So Long to figure out why homes don't use the bathrooms for hallways. The Livability is just like home.



Motor home floorplans have evolved to fit the available space, and the lack of space has resulted in some solutions that we all accept given the limitations. The So Long eliminates the limitations.

All New 2007 Floorplans

Founder

Model # 1009-SYFE35LS

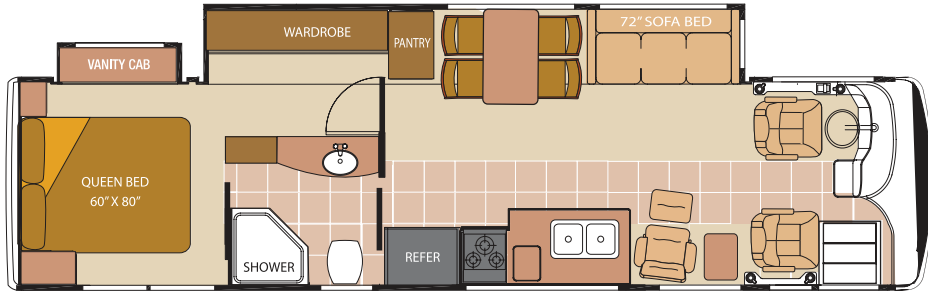

35' Walk-Thru Bath Neo Angle Shower
Living Room Option I Free Standing Dinette

Founder

Model # 1012-SYF37LS

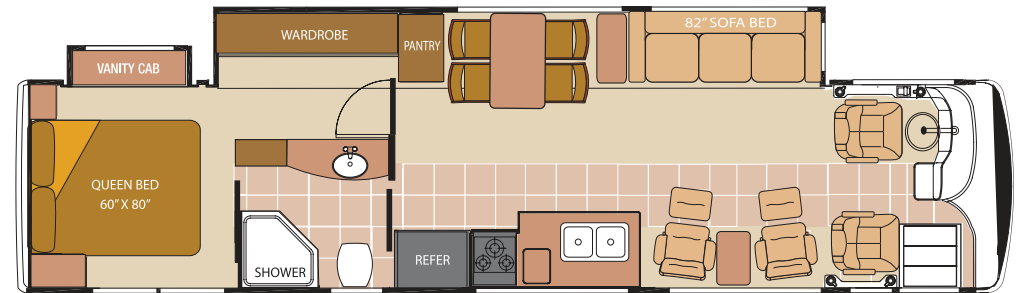

37' Walk-Thru Bath Neo Angle Shower
Living Room Option I Free Standing Dinette

Founder

Model # 1011-SYFE40LS

See-Ya!

Model # 1007-SY40LS

See-Ya! GOLD

Model # 1008-SYG40LS

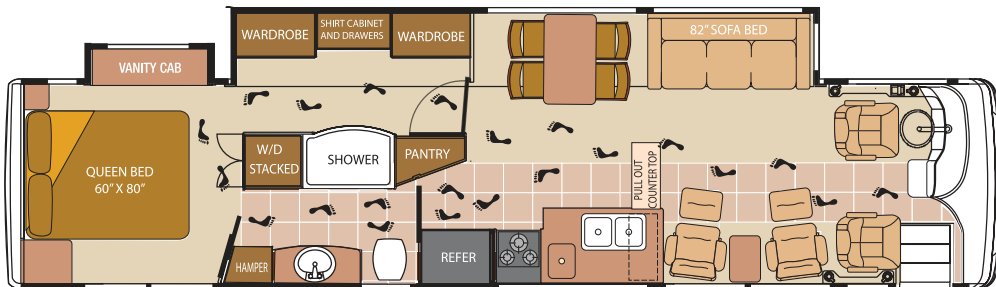

40' Walk-Thru Bath Garden Tub
Living Room Option I Free Standing Dinette

Founder

Model # 1010-SYFE40FD

See-Ya!

Model # 1004-SY40FD

See-Ya! GOLD

Model # 1002-SYG40FD

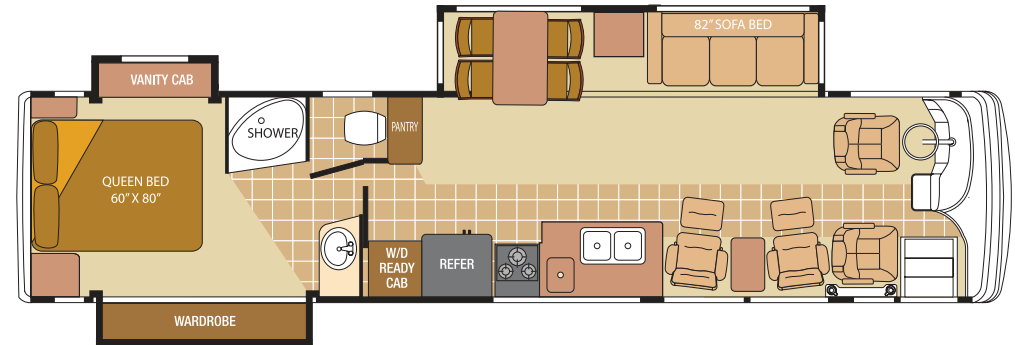

40' Walk-Thru Bath Garden Shower
Living Room Option I Free Standing Dinette

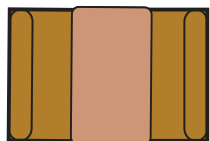

Booth Dinette Option

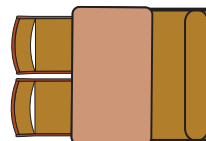

Half Booth
&
Half Free Standing Dinette Option



J-Lounge Option

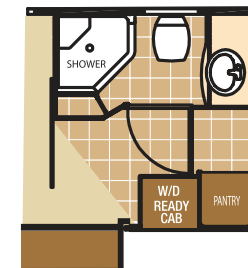

Private Bath option



55° WHEEL CUT*

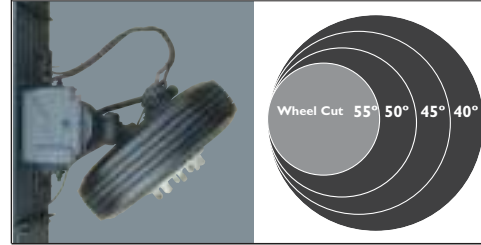

- Freightliner Custom Chassis
- Many Competitors' Chassis

*55-Degree Wheel Cut on chassis equipped with AAC Wide Track Front Axles



The XC Chassis

Common Alfa Chassis Specifications

16.5" x 7" drum-style S-cam, spring-applied, air-released drum-style parking brake (rear axle)

16.5" x 7" drum-style, S-cam rear brakes

18" VIP steering wheel

Air compressor

Air conditioning condenser

Air filter restrictor indicator

Air suspension deflation system

Alternator - 160-amp

Tilt/telescoping steering column

Electronic cruise control with high idle

Engine clutch fan

Fuel/water separator

Full air brakes with auto slack adjusters and ABS Gauges incl. speedometer, odometer, tachometer, engine oil pressure, water temperature, coolant level

Heated automatic moisture ejector

In-block engine heater

Pure Air Plus heated air dryer

Neway® air suspension (front & rear)

R-134A air conditioning compressor

Radiator : 1,050 sq. in. cross flow, rear-mounted

Raised frame rail construction

Sachs tuned shock absorbers

Transmission air cooler remote-mounted, water-to-oil

Farr-Eco air cleaner

Freightliner XC Raised Rail Chassis

Founder

FRONT AXLE - Meritor Front Axle I-beam Wide Track - Capacity: 10,500 Lbs • **REAR AXLE** - Meritor Rear Axle - Capacity: 19,000 Lbs. • **BRAKES** - Full Air Over Drum 15" x 4" Front & 16.5" x 7" Rear With Auto-Slack Adjusters And ABS • **CHASSIS** - Freightliner XC Chassis - G.V.W.R. - 29,500# • **ENGINE** - Caterpillar C-7 300 Hp @2400 rpm Turbocharged Aftercooled 7.2l Diesel Engine • **ENGINE BRAKE** - Turbo Exhaust Retarder From PAC • **FOOT PEDALS** - Stationary Foot Pedals • **FUEL TANK** - 90 Gallon Fuel Tank • **SUSPENSION** - Trailing Arm - Newway Air Suspension • **TIRES** - 255/80R22.5 Size Tires - Load Range G • **WHEEL BASE** - 35' - 228" / 40' - 252" • **WHEEL CUT** - 55 Degree Wheelcut - On Front Steering In Both Directions • **WHEELS** - Steel With Polished Hub Caps

See Ya!

FRONT AXLE - Meritor Front Axle I-beam Wide Track - Capacity: 12,000 Lbs • **REAR AXLE** - Meritor Rear Axle - Capacity: 20,000 Lbs. • **BRAKES** - Full Air Over Drum 15" x 4" Front & 16.5" x 7" Rear With Auto-Slack Adjusters And ABS • **CHASSIS** - Freightliner XC Raised Rail Chassis - G.V.W.R. - 32,000# • **ENGINE** - Mercedes-Benz MBE 926 330 HP 1,000 lb-ft Torque 7.2 • **ENGINE BRAKE** - Turbo Exhaust Retarder From PAC • **FOOT PEDALS** - Stationary Foot Pedals • **FUEL TANK** - 100 Gallon Fuel Tank • **SUSPENSION** - Trailing Arm - Newway Air Suspension • **TIRES** - 275/80R22.5 Size Tires - Load Range G • **WHEEL BASE** - 40' - 252" • **WHEEL CUT** - 55 Degree Wheelcut On Front Steering In Both Directions • **WHEELS** - Steel With Polished Hub Caps

See Ya! Gold

FRONT AXLE - ZF Independent Front Suspension - Capacity: 14,600 Lbs • **REAR AXLE** - Meritor Rear Axle - Capacity: 20,000 Lbs. • **BRAKES** - Front-Full Air Over 17" Disk / Rear-Full Air Over Drum With Auto-Slack Adjusters And ABS • **CHASSIS** - Freightliner XC Raised Rail Chassis - G.V.W.R. - 34,320# • **ENGINE** - Cummins ISL 400hp @ 1900 Rpm - Turbocharged Aftercooled - 8.9l Engine • **ENGINE BRAKE** - C-brake From Jacobs • **FOOT PEDALS** - Adjustable Foot Pedals • **FUEL TANK** - 150 Gallon Fuel Tank • **SUSPENSION** - ZF IFS Independent Air Ride Suspension • **TIRES** - 275/80R22.5 Size Tires - Load Range H • **WHEEL BASE** - 40' - 252" • **WHEEL CUT** - 56 Degree Wheelcut On Front Steering In Both Directions • **WHEELS** - Aluminum With Valve Extensions

Common

Air Conditioning Compressor R-134A and Condenser • Air Cleaner Restriction Indicator • Air Compressor with Heated Air Dryer • Allison 3000 MH 6 Speed Automatic Transmission with Push Button Shift Control • 160 Amp Alternator • 2 Alliance 12V Batteries • Dual Air Tanks with Automatic Moisture Ejectors • Cruise Control • Daytime Running Lights • Fuel / Water Separator • Electric 4 Point Leveling Jacks • Multiple Module Data Computer Information Center with Lcd Display • Newway Air Ride Suspension with Manual Deflation Valve and Sachs Shock Package • Rear Mounted Cross Flow 1050 Square-Inch Radiator • Tran-Synd Transmission Fluid • 1000 Watt / 115 Volt Block Heater

2007 Model Specifications

	See-Ya! GOLD		See-Ya!		Founder Edition			
	1002 SYG40FD	1008 SYG40LS	1004 SY40FD	1007 SY40LS	1009 SYFE35LS	1010 SYFE40FD	1011 SYFE40LS	1012 SYFE37LS
Weights in Pounds								
FGAWR	14,320	14,320	12,000	12,000	10,500	10,500	10,500	10,500
RGAWR	20,000	20,000	20,000	20,000	19,000	19,000	19,000	19,000
GVWR	34,320	34,320	32,000	32,000	29,500	29,500	29,500	29,500
UVW	29,520	29,400	26,980	26,840	23,500	24,920	24,800	24,800
GCWR	44,320	44,320	42,000	42,000	33,000	39,500	39,500	39,500
Measurements								
Wheel base	252"	252"	252"	252"	228"	252"	252"	252"
Overall Length	39'-11"	39'-11"	39'-11"	39'-11"	36'-7"	39'-11"	39'-11"	39'-11"
Overall Height	13'-1"	13'-1"	13'-1"	13'-1"	13'-1"	13'-1"	13'-1"	13'-1"
Interior Height	7'-6"	7'-6"	7'-6"	7'-6"	7'-6"	7'-6"	7'-6"	7'-6"
Exterior Width	102"	102"	102"	102"	102"	102"	102"	102"
Interior Width	95"	95"	95"	95"	95"	95"	95"	95"
Tank Capacities in Gallons								
LP Tank	38	38	38	38	25	25	25	25
Fuel Tank	150	150	100	100	90*	90*	90*	90*
Water Heater	10	10	10	10	10	10	10	10
Fresh Water	100	100	100	100	100	100	100	100
Gray Tank	73	73	73	73	73	73	73	73
Black Tank	40	37	40	37	37	37	37	37

*All weights, measurements and capacities are approximate **Heights may vary due to vehicle loading ***Weights are best estimate at time of printing

Summary of Alfa's Limited Warranty*

In order for your warranty to be valid, you need to read and understand this agreement, initial it where indicated, and sign it, signifying your acceptance of its terms and conditions.

I. WHAT IS COVERED

This limited warranty is for Alfa Leisure, Inc. ("ALFA") trailers and motorhomes registered in the United States and normally operated or used in the United States or Canada, and is provided to the original retail purchaser of the trailer and motorhome. For all of our trailers and motorhomes, Alfa warrants that all parts of our manufacture are free from substantial defects in material and workmanship under normal use, except those items listed below under Section V, "What Is Not Covered."

This warranty is not intended to replace, nor does it replace, any of the valid warranties separately given on appliances and equipment manufactured by third parties and installed by Alfa on your new Alfa trailer or motorhome, including but not limited to, (in the case of motorhomes) all other separately warranted appliances, parts or components. However, Alfa will assist you in enforcing these valid third party warranties (except for tires and batteries) throughout the term of this warranty, upon presentation of proof of your compliance with the warranty procedures required by the appropriate third party appliance or equipment manufacturer. Please refer to the written warranties issued by such component manufacturers for the terms and provisions of their written warranty undertakings and requirements. Warranty information with respect to these items is available from your dealer and should be included in your trailer or motorhome upon retail delivery. As to items or components separately warranted by their manufacturer, Alfa's warranty only covers them from the time that their respective manufacturer's warranties end through the end of Alfa's warranty period.

II. WHAT ALFA WILL DO

This is a limited warranty, as described in the Magnuson-Moss Warranty Federal Trade Commission Improvement Act (15 U.S.C. 2301, et seq.). In the event that an Alfa trailer or motorhome has a substantial defect in material or workmanship under normal use, Alfa will repair the defect under the terms of this limited warranty. Needed repairs covered under this limited warranty may be performed using new or remanufactured parts, at Alfa's election.

III. WARRANTY PERIOD

The warranty period begins on the date the trailer or motorhome is first delivered to you, the original retail purchaser, and extends for a period of one (1) year from such date, or in the case of a motorhome for 18,000 miles, whichever comes first. Written notice of any covered defect must be given to Alfa no later than the last day of the warranty period, and repairs must be made or initiated no later than forty five (45) days after the warranty period ends. Any defect that is not reported during the warranty period is not covered.

IV. LIMITATIONS AND EXCLUSIONS

THIS LIMITED WARRANTY IS NOT TRANSFERABLE UNLESS REQUIRED BY LAW. ANY IMPLIED WARRANTIES, INCLUDING IMPLIED WARRANTIES OF MERCHANTABILITY AND FITNESS, ARE LIMITED IN DURATION TO THE WARRANTY. SOME STATES DO NOT ALLOW LIMITATIONS ON HOW LONG AN IMPLIED WARRANTY WILL LAST OR THE EXCLUSION OR LIMITATION OF INCIDENTAL OR CONSEQUENTIAL DAMAGES, SO THE ABOVE LIMITATIONS AND EXCLUSIONS MAY NOT APPLY TO YOU. THIS WARRANTY GIVES YOU SPECIFIC LEGAL RIGHTS, AND YOU MAY ALSO HAVE OTHER RIGHTS, WHICH VARY FROM STATE TO STATE.

V. WHAT IS NOT COVERED

This warranty does not cover the following:

- A. Batteries, hubcaps, light bulbs, shock absorbers, tires, upholstery, wheels, and wheel trim, unless being repaired or replaced due to damage resulting from a covered defect.
- B. Any trailer or motorhome defect, damage or malfunction caused by or resulting from abuse, misuse, negligence, accident, collision, fire, theft, vandalism, riot, explosion, an act of war or terrorism, or objects striking the trailer or motorhome.
- C. Any trailer or motorhome defect, damage or malfunction caused by post-manufacture alteration or modification made to your trailer's or motorhome's original equipment as manufactured, installed and/or assembled by Alfa, including but not limited to the installation of any custom or add-on part, alarm or alarm system, oversized or undersized tires, trailer hitch, or any modification or alteration of the trailer or motorhome's frame or suspension components.
- D. Any trailer or motorhome defect, damage or malfunction caused by your failure to exercise reasonable care to protect against and avoid further damage to your trailer or motorhome after you knew or should have known of the existence of a defect, breakdown or component failure.
- E. Any trailer or motorhome defect, damage or surface corrosion, subsequent to manufacture, solely caused by or resulting from the environment, such as moisture, acid rain, lightning, airborne fallout, earthquake, freezing, rust, oxidation, windstorm, salt, sand, wind, chemicals in the surrounding air, pollution, salt water, hail, flood, rodent, animal or insect infestation, mold, mildew, or any other external environmental condition.
- F. Any trailer or motorhome defect or damage caused by or related to condensation in the interior of the trailer or motorhome, except for condensation occurring in the interior of double-paned windows, between the panes.
- G. Any trailer or motorhome defect or damage caused by or related to normal wear, usage and deterioration, such as fading or discoloration of soft goods (upholstery, drapes, carpet, vinyl, screens, cushions, mattresses), fading or discoloration of exterior plastic or fiberglass components, tears, punctures and soiling.
- H. Any trailer or motorhome defect or nonconformity that is not reported to Alfa or an authorized Alfa dealer or service center during the warranty period.
- I. Any repair performed without prior authorization from Alfa.
- J. Squeaks, creaks, pops, wind noise and other such subjective noises, which are normal for trailers and motorhomes and are not related to or caused by any covered defect.

ALFA Leisure, Inc. reserves the right to make changes at any time, without notice or obligation, in prices, colors, materials, equipment, specifications, weights and models. * All weight indications in this brochure are approximate. The manufacturer reserves the right to improve and change models without incorporating these changes in similar models produced at an earlier date. Because of this, we suggest you consider these factors when ordering a unit for future delivery.

- K. Any minor cosmetic flaw, damage or imperfection which is normal in the manufacture, shipping and display of trailers or motorhomes and does not substantially affect the suitability of the trailer or motorhome for its intended purpose of recreational use.
- L. The cost of any normal trailer and motorhome maintenance service or parts, including but not limited to, alignment, suspension, wheel balancing, filters, fluids, lubricants, engine coolant, brake pads, brake rotors, brake drums, brake linings and shoes, engine tune up, and spark/glow plugs. However, such cost will be included if incurred as a result of a breakdown caused by a defect or malfunction covered by this warranty.
- M. The cost of any labor or replacement parts which are not reasonably necessary to correct or repair a covered defect, but which a service or repair facility may recommend or require as part of the overall repair.
- N. Economic loss or extra expense, including, but not limited to physical damage, property damage, transportation to and from dealer or manufacturer locations, loss of trailer or motorhome use, storage, loss of time, profits, wages or pay, inconvenience, vehicle rental expense, lodging, meal or other travel costs, state or local taxes required on warranty repairs, commercial loss or any other loss that results from any trailer or motorhome defect, malfunction or breakdown which is not otherwise covered under this warranty.
- O. Costs incurred for transportation of the trailer or motorhome to a dealer, costs incurred as the result of a request to have repairs performed at a location other than an authorized dealership, or costs incurred for service calls, mileage charges or other similar fees associated with the use of a mobile service provider, unless deemed necessary by Alfa and approved by Alfa in advance of such costs being incurred.
- P. Any breakdown that occurs and/or repairs made outside of the United States of America and Canada.
- Q. Any trailer or motorhome used as a commercial unit, a rental unit, taxi, limousine or shuttle, or for commercial delivery, towing or road repair operations, construction job site activities, hauling freight, police or emergency service, principally off road use, racing, competitive driving, snow removal, road work, service or repair.
- R. Any Alfa trailer or motorhome currently or previously titled as salvaged, scrapped, junked, dismantled or totaled.
- S. For any Alfa motorhome, the chassis and any mechanical parts, including the engine, drive train, steering system, brake system, wheels, tires, lug nuts, muffler and any other parts, manufactured or assembled by the chassis manufacturer.
- T. Any undertaking, representation or warranty made by any dealer, or third party, that is not contained within this limited warranty. Alfa does not authorize any person to create for it any obligation, warranty or liability in connection with Alfa trailers or motorhomes.

VI. HOW TO OBTAIN WARRANTY SERVICE

For this limited warranty to apply, you must, within the warranty period, provide Alfa: (a) notice of the defect or defects; (b) reasonable opportunity to inspect the trailer or motorhome; (c) a reasonable attempt or, depending on the law to be applied and the nature of the defect, reasonable attempts to repair the trailer or motorhome; and (d) a reasonable period of time for repair following delivery of the defective trailer or motorhome to Alfa or to an authorized service or repair facility.

In the event the need for repair of a defect covered under this warranty arises, Alfa will bear the cost of the repair or replacement of such defective materials or workmanship, provided that you follow these procedures:

- A. Avoid further damage to your trailer or motorhome. This may mean ceasing operation of the trailer or motorhome or the component that is failing or has failed.
- B. Arrange to have the trailer or motorhome taken to an authorized Alfa dealer or service center near you. You may contact Alfa for assistance in locating an authorized dealer or service center near your current location. The dealer or service center will inspect and diagnose the cause of failure and estimate the cost of parts and labor to complete the repair. If a failure or defect is not covered by this warranty, all costs incurred, including costs for disassembly and/or diagnostic work are solely your responsibility.
- C. You or the dealer or service center must, within a reasonable time after discovering a defect covered under this warranty, notify Alfa of the defect and the need for repair. You or the dealer or service center must also contact Alfa and obtain authorization and an authorization number before starting any repair work in order for the covered parts and labor associated with such repairs to be paid under this warranty. Depending on the circumstances, Alfa reserves the right to reasonably inspect or investigate the complaint or defect before authorizing the performance of any repair. In the event of an irreconcilable dispute over a repair, parts or labor as between Alfa and a dealer or service center, Alfa shall have the right to send your trailer or motorhome to another repair facility of its choice in order to complete the repair of any item covered by this warranty.
- D. Alfa Leisure must approve and authorize any covered repair before work is started, and give the dealer an authorization number. At Alfa's sole discretion, unauthorized repair costs may not be covered.
- E. You must permit a reasonable inspection of your trailer or motorhome before repairs are made, and you are responsible to pay for any non-covered charges you incur in connection with your trailer or motorhome.
- F. You must allow the authorized dealer or service center a reasonable time to perform the necessary repairs.
- G. Approved claims for repair of defects covered under this warranty must be sent to the following address for reimbursement:

Alfa Leisure, Inc.
Attention: Warranty Department
13501 5th Street
Chino, CA. 91710

IMPORTANT: If you are unable to resolve any particular defect claim in one (1) visit to a dealer or service center and must return your trailer or motorhome for a second (2nd) attempt to repair the same defect, you must call Alfa at the second attempt hotline (888) 590-4485 for assistance with your warranty claim.

Join the family – the family of Alfa owners

Join the fun, cherish the memories. **Your first year's membership in the ALFA Owners Club is included with the purchase of your ALFA.** Travel to exciting destinations with quality minded people like yourself. Numerous activities are hosted by local chapters, leading up to the annual national rally. Your adventure of a lifetime may be just beginning with your ALFA purchase.



2006 National Rally

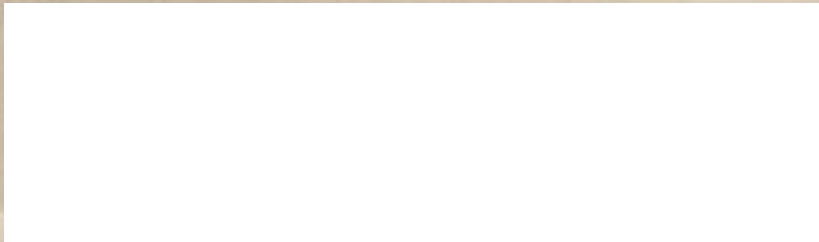

ALFA LEISURE, Inc., 1612 S. Cucamonga, Ontario, CA 91761 • (909) 628-5574 • www.alfaleisure.com

©2005 Alfa Leisure, Inc. All Rights Reserved Printed in the U.S.A. All specifications and features apply to product manufactured at time of publication.

ALFA Leisure reserves the right to make product changes without notice and without incorporating them in similar models on another date. Every effort has been made to avoid printing errors, however, if there are any specification or printing errors, we disclaim responsibility and liability.