

PHAETON[®]

29

TIFFIN MOTORHOMES



TIFFIN MOTORHOMES
WHEREVER YOU GO, WE GO.



2012 PHAETON

BUILT TO PERFORM. PRICED TO COMPETE. Consistently Tiffin's bestselling model, the Phaeton ranks among the top-selling Class A motor homes in the industry. It's easy to see why. Few coaches anywhere deliver more luxury and practicality at a greater value than this diesel pusher model, and the standard of excellence gets higher every year. To advise us on new enhancements, we turn to the folks who know it best—current Phaeton owners. Always a valued resource, customer feedback leads to handy modifications, such as relocating the 110-volt plug or adjusting the compartment door height. We've also expanded the available options on two floor plans to enable you to enjoy the luxury and convenience of tile throughout the entire coach. Our designers are masters of innovation and from front to back, top to bottom, the 2012 model is filled with features to make life on the road better than ever.

Welcome to the great indoors.

We're not saying the living area is as big as a stadium, but with two comfy sofas, driver and passenger seats, seven foot ceilings, four slides, and floor plans up to 42 feet, there's room for a sizeable crowd. Everyone gets a front row view, with a 32" TV in both living room and bedroom, an optional 37" front overhead TV, and an optional 32" exterior TV. An automatic or in-motion satellite dish is also optional. Cooking for the gang is a piece of cake in the smartly organized kitchen outfitted with a convection microwave, three-burner cooktop, and a residential refrigerator with a gas/electric option. Along with the Expand-an-island, there's even more counter space with solid surface covers over the cooktop and sink. With cabinets above and below, pantry organization is easy - good news for anyone in search of a midnight snack.



40 QBH Floor Plan/Capri Interior with English Chestnut Cabinets



U-SHAPED BOOTH DINETTE

Who needs take-out? This diner is always open. After the dishes are cleared, it becomes the perfect place for a game of cards.



KITCHEN

An ingenious layout puts everything within reach for easy meal preparation. There's not an inch of wasted space anywhere.



The perfect place to retire.

After a day of fun in the sun, nothing will feel as good as stretching out on the queen-sized bed or the king option in the Phaeton master suite. Get even more comfort with a dual control bed system or a memory foam mattress. Guests will be just as cozy on the two sleeper sofas in the living area. As for the kids, we offer a floor plan with bunk beds and optional DVD players they'd love to claim as their own. Family belongings stay tidy with a chest of drawers, large closet, under bed storage, and a laundry hamper. The bath area is separate, offering a luxurious shower stall with glass surround, hand-held shower head, and skylight with sliding cover. Floor plans that include a bath-and-a-half option are available for those who prefer more privacy.

WASHER/DRYER

Save your quarters with the convenience of an onboard stackable unit. Tiffin chooses its appliances to meet the highest performance standards.



40 QBH Floor Plan/Capri Interior with English Chestnut Cabinets

BEDROOM STORAGE

Convenient storage keeps the bedroom neat and tidy. A multitude of drawers keep family belongings separated and organized.



MASTER BATH

Welcome to your private sanctuary. The skylight has a sliding cover, enabling you to relax with a soothing shower under the sun or stars.



40 QBH Floor Plan/Capri Interior with English Chestnut Cabinets

A moving experience.

There's nothing quite like getting behind the wheel of the Phaeton for the first time. You'll instantly feel a sense of command, as safety and comfort are built into every detail. The power Ultra Leather driver and passenger seats are welded directly to the chassis for added security. Surrounding the 18-inch VIP Steering Wheel is a cleverly organized dash with everything in easy reach, ensuring your focus stays on the road. Superior engineering delivers fuel efficiency without compromising horsepower. Three chassis options, Freightliner, Spartan, and Tiffin's own PowerGlide[®], are equipped with a 380-horsepower Cummins engine and the 42-foot models are outfitted with the new ISL 400-horsepower engine. With a 10,000-pound capacity trailer hitch, you have the power to tow a car, a boat, or just about anything you want.



Cockpit with Navigation System and Flexsteel[®] Ultra Leather Power Seats

NAVIGATION SYSTEM

No need to stop and ask for directions. With an optional state-of-the-art system guiding every mile of the way, your trip stays right on course.



SLIDING STORAGE

There's no need to crawl in this crawl space. These optional sturdy slide trays easily extend to provide quick access to stored items.



EXTERIOR ENTERTAINMENT CENTER

Treat the family to a modern version of the drive-in movie. Pull up a lawn chair and enjoy the great outdoors with an optional outdoor TV.



Driven By You

Top performance begins from the road up. Tiffin Motorhomes is proud to offer the Freightliner® Chassis, our standard chassis on the Phaeton, as our two companies share a deep commitment to excellence and customer service. In our long association, Freightliner has earned a stellar reputation with Tiffin owners by delivering a premium ride, more maneuverability, ongoing owner education, a nationwide service network, and 24/7 factory direct customer support. Their warranty offers the assurance of comprehensive coverage: a transferable, 3-year, 50,000-mile limited warranty with towing and roadside assistance with no deductible. The Allison® transmission is covered with a 5-year unlimited mileage warranty and the Cummins® engine provides a 5-year, 100,000-mile warranty. For more information about the XC-R motor home chassis, visit freightlinerchassis.com



Freightliner® Custom Chassis

- 1 Tilt-and-telescoping steering column adjusts for driver comfort
- 2 55° wheel cut for greater maneuverability
- 3 18" VIP Steering Wheel
- 4 Large air springs with ping tanks for a superior ride
- 5 Large volumetric air springs and transverse beam provide superior ride and roll stability
- 6 Custom-tuned Sachs shock absorbers
- 7 9" high steel frame rails with cross-members for solid foundation
- 8 Cummins ISC Engine 380 HP/1050 Lb. torque or Cummins ISL Engine 400 HP/1250 Lb. torque (42' only)
- 9 Engine position provides better ride and smoother handling
- 10 Electronically controlled viscous on/off fan clutch provides improved fuel economy and performance

Interior Décor

As attractive as Tiffin coaches are on the outside, the interior is where we excel. After all, this is the place you call home. Our interior designers have put together a selection of neutral color schemes to suit many decorating styles. Last year's popular White Diamonds option is still available, along with two new interior schemes, Capri and Palmetto. Each option beautifully complements the tones found in the decorative accents and the hardwood cabinetry handcrafted in our Red Bay mill shop.

Cabinets



Medium Alderwood



English Chestnut



Cherry Bark

Flooring & Countertops



Carpet



Tile



Countertop

Capri Fabric Suite

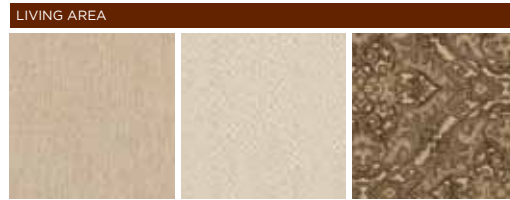

Sofa

Accent

Dinette

Palmetto Fabric Suite



Sofa

Accent

Dinette

White Diamonds Fabric Suite

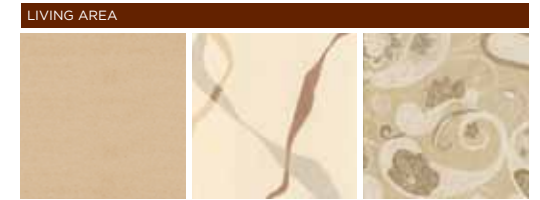

Sofa

Accent

Dinette

BEDROOM



Main

Accent

BEDROOM



Main

Accent

BEDROOM



Main

Accent

Phaeton cabinet doors are made of solid wood, and all cabinet finishes are available in combination with any fabric suite. All options may not be available in every model. Because of progressive improvements, specifications, standard & optional equipment are subject to change without notice or obligation. For a complete and up-to-date list of available options and specifications, visit tiffinmotorhomes.com



Gold Coral



Silver Sand



Maroon Coral



Sunlit Sand



Rustic Canyon



Rocky Mountain Brown

Full-body Paint Schemes

Full-body paint is standard on all 2012 Phaetons. Front caps are coated with a special paint protective film, which helps retain the fresh-painted sheen, as well as sealing in the paint to make it last longer. Tiffin's paint facility is one of the largest in the country and features a state-of-the-art air filtration system that helps ensure an impeccable finish. Quality control checks are integrated into the painting process. Meticulous attention is given to every single inch of the coach to produce the most precise application.

Floor Plans* & Options

There's a Phaeton floor plan perfect for how you live. Prefer privacy? Among the options are two floor plans that allow guests to freshen up in a powder room without having to walk through your bedroom to get to the bath. There's also a more kid-friendly option with bunk beds and DVD options.

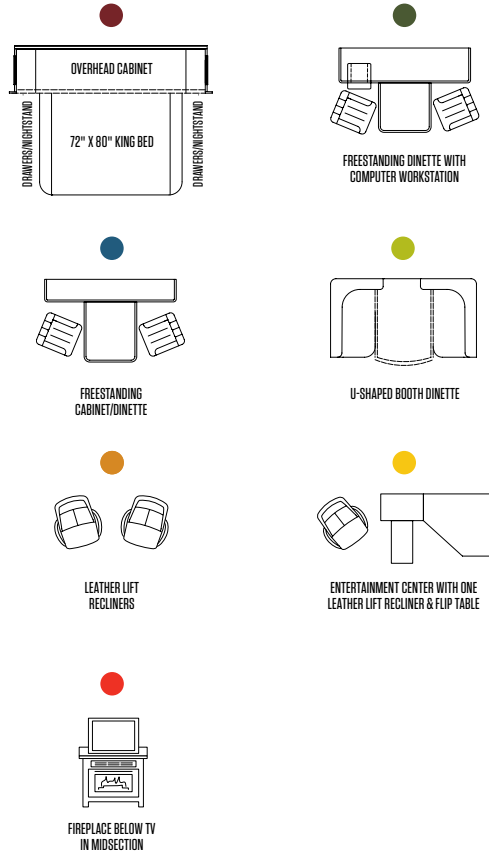

36 QSH

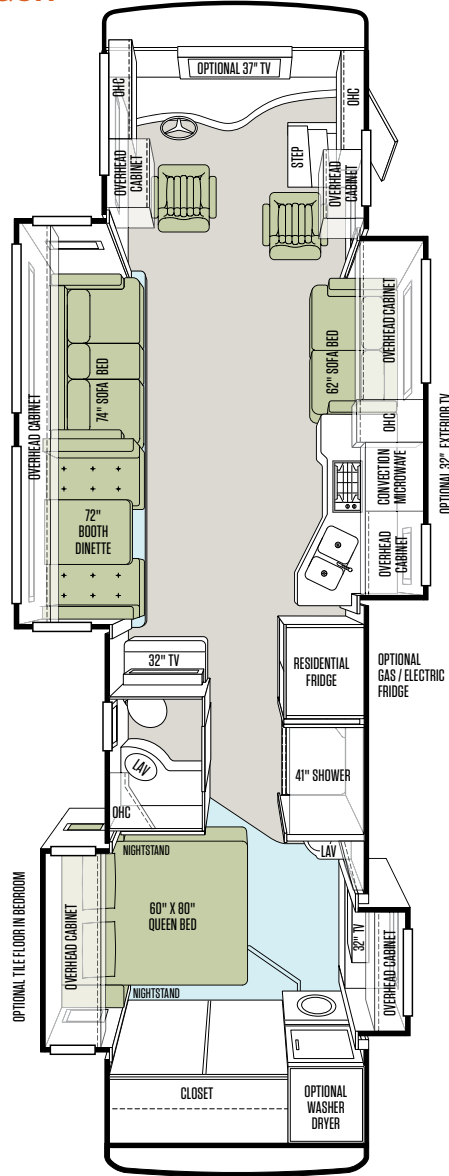

40 QBH

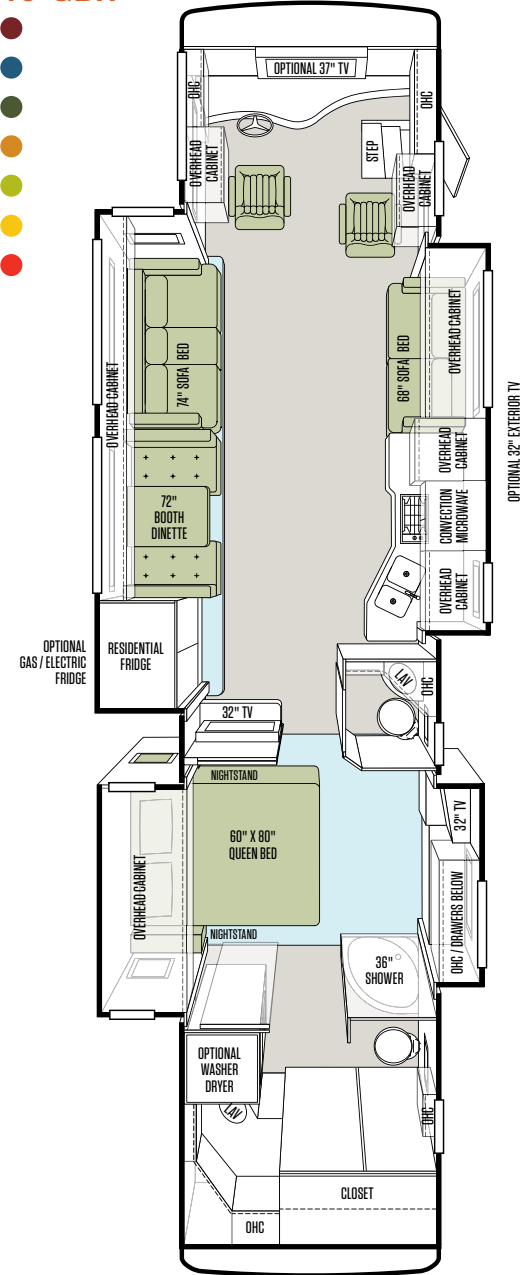

*Additional floor plans may be added throughout the model year. For a complete and current list of available floor plans and options, visit us online at tiffinmotorhomes.com

40 QKH

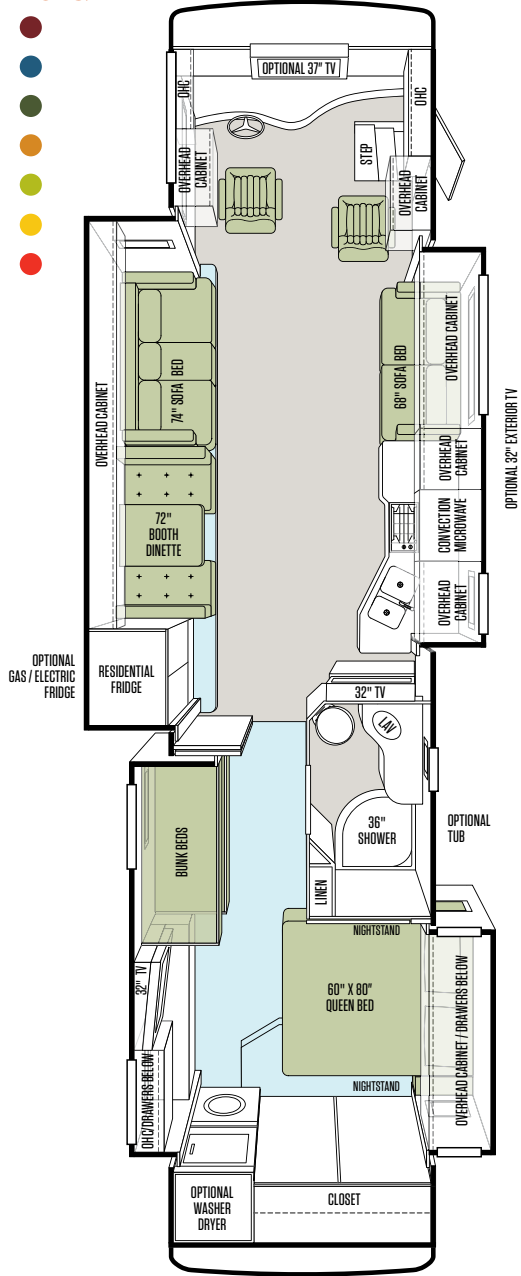

40 QTH

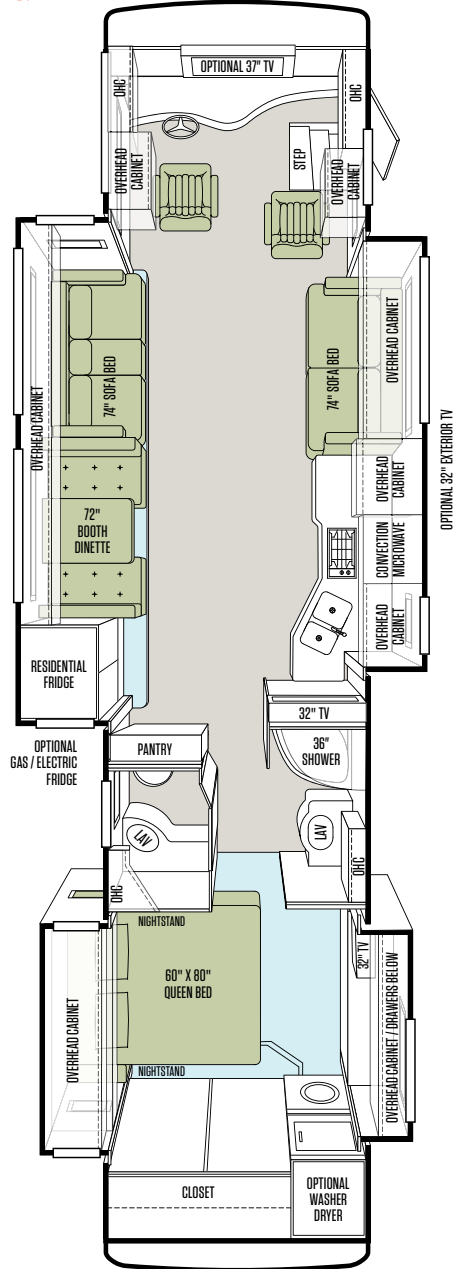

42 QBH

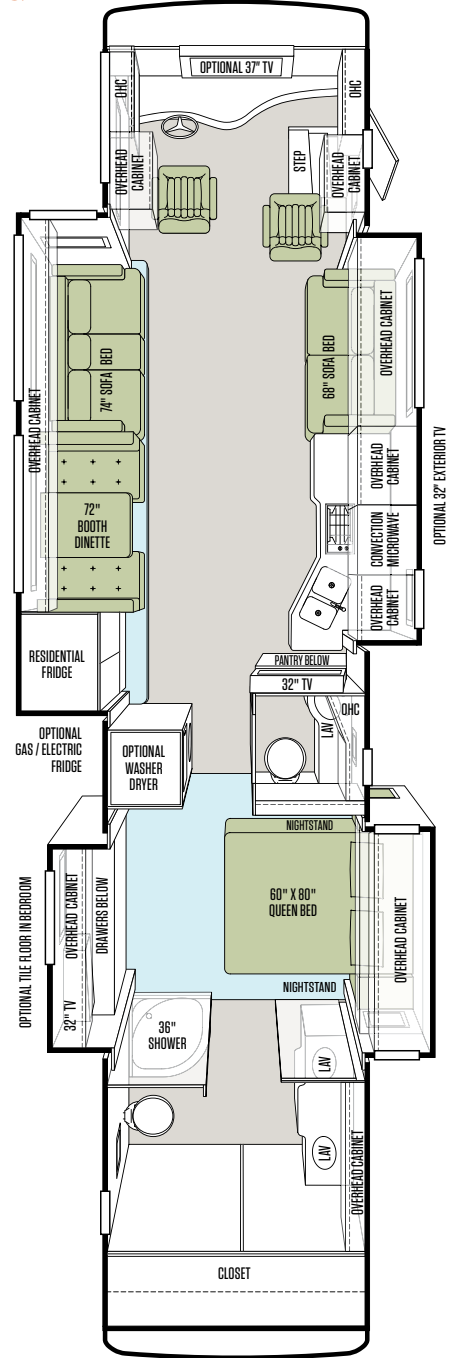

Specifications

Automotive

STANDARD ON ALL MODELS:

- Raised Rail Chassis Frame
- Air Ride (4 Air Bags)
- Aluminum Wheels
- Exhaust Brake (36' & 40')
- Compression Brake (42')
- Adjustable Accelerator & Brake Pedals
- Allison 3000 MH 6-speed Automatic Transmission
- Air Brakes with Automatic Slack Adjusters & ABS
- 55° Wheel Cut
- Fog Lights
- Daytime Running Lights
- 18" VIP Steering Wheel
- Cruise Control
- Emergency Start Switch

Chassis Options

FREIGHTLINER® AND SPARTAN® CHASSIS:	36 QSH	40 QBH	40 QKH	40 QTH	42 QBH
Freightliner Cummins ISC 380 HP/1050 Lb. Torque	S	S	S	S	NA
Freightliner Cummins ISL 400 HP/1250 Lb. Torque	NA	NA	NA	NA	S
Spartan Cummins ISC 400 HP/1200 Lb. Torque	NA	NA	NA	NA	O
GVWR	32,400 Lb.	32,400 Lb.	32,400 Lb.	32,400 Lb.	45,000 Lb.
GAWR—Front	12,400 Lb.	12,400 Lb.	12,400 Lb.	12,400 Lb.	14,000 Lb.
GAWR—Rear	20,000 Lb.	20,000 Lb.	20,000 Lb.	20,000 Lb.	21,000 Lb.
GAWR—Tag Axle	NA	NA	NA	NA	10,000 Lb.
GCWR	42,400 Lb.	42,400 Lb.	42,400 Lb.	42,400 Lb.	55,000 Lb.
Alternator Amps	160	160	160	160	160
Trailer Hitch Capacity	10,000 Lb.	10,000 Lb.	10,000 Lb.	10,000 Lb.	10,000 Lb.
Fuel Tank (Gallons)—Dual Fuel Fill	100	100	100	100	100
DEF Tank* (Gallons)	13	13	13	13	13
POWERGLIDE® CHASSIS:	36 QSH	40 QBH	40 QKH	40 QTH	42 QBH
Cummins ISC 380 HP/1050 Lb. Torque		S	S	S	
GVWR	PowerGlide	36,000 Lb.	36,000 Lb.	36,000 Lb.	PowerGlide
GAWR—Front	Chassis	14,000 Lb.	14,000 Lb.	14,000 Lb.	Chassis
GAWR—Rear	Not	22,000 Lb.	22,000 Lb.	22,000 Lb.	Not
GAWR—Tag Axle	Available	NA	NA	NA	Available
GCWR	on	46,000 Lb.	46,000 Lb.	46,000 Lb.	on
Alternator Amps	This	170	170	170	This
Trailer Hitch Capacity	Model	10,000 Lb.	10,000 Lb.	10,000 Lb.	Model
Fuel Tank (Gallons)—Dual Fuel Fill		100	100	100	
DEF Tank* (Gallons)		15	15	15	

Weights & Measures

OVERALL:	36 QSH	40 QBH	40 QKH	40 QTH	42 QBH
Overall Length (Approximate)	36' 9"	40' 5"	40' 5"	40' 5"	42' 6"
Overall Height with Roof Air (Maximum)	12' 7"	12' 7"	12' 7"	12' 7"	12' 7"
Interior Height	84"	84"	84"	84"	84"
Overall Width	101"	101"	101"	101"	101"
Interior Width	96"	96"	96"	96"	96"
Fresh Water (Gallons)	90	90	90	90	90
Black Water (Gallons)	50	50	50	50	50
Grey Water (Gallons)	70	70	70	70	70
LPG Tank (Gallons; can only be filled to 80% capacity)	35.7	35.7	35.7	35.7	35.7
Basement Storage (Cubic Feet - Approximate)	151	177	177	177	154
Wheel Base	228"	266"	266"	266"	296"
Tire Size	275/80R22.5	275/80R22.5	275/80R22.5	275/80R22.5	275/80R22.5
Minimum Garage Height	13'	13'	13'	13'	13'

*Diesel Exhaust Fluid (DEF) is the active component used in Selective Catalytic Reduction (SCR) engines to reduce nitrogen oxide emissions by 90% to meet EPA standards.

All options may not be available in every model. Because of progressive improvements, specifications, standard & optional equipment are subject to change without notice or obligation. For a complete and up-to-date list of available options and specifications, visit tiffinmotorhomes.com

Exterior

STANDARD ON ALL MODELS:

- Hydraulic Automatic Leveling Jacks
- Large Tinted One-piece Windshield
- Heated Power Mirrors with Integrated Cameras
- Single Motor Intermittent Wiper
- Lockable Swing-out Storage Doors with Gas Shocks
- Window Awning Package (2 Windows)
- BASF Full-body Paint with Protective Film on Front Cap
- Remote Locking System for Entry Door
- Heated Water & Holding Tank Compartments
- Deadbolt Front Entrance Door
- Double Electric Step
- Dual Pane Windows
- Exterior Patio Light
- Automatic Door Awning
- Automatic Patio Awning
- Lighted Exterior Storage
- Roof Ladder
- Fiberglass Front & Rear Caps
- Docking Lights
- Six 6 V Auxiliary Batteries
- Park Telephone Ready
- Black Tank Flush System
- Water Filter
- Custom Mud Flap
- Undercoating
- Dual Fuel Fills
- 110 V Exterior Receptacle
- Digital TV Antenna
- Power Fantastic® Roof Vent with 3-speed Fan
- Back-up Camera
- Cable Ready TV
- Gravity Water Fill
- 2000 Watt Inverter with 100 Amp Converter & Transfer Switching

AVAILABLE OPTIONS:	36 QSH	40 QBH	40 QKH	40 QTH	42 QBH
Spotlight	O	O	O	O	O
One Storage Compartment Slide-out Tray	O	O	O	O	O
Two Storage Compartment Slide-out Trays	NA	O	O	O	O
Hadley Air Horns	O	O	O	O	O
In-motion Satellite Dish*	O	O	O	O	O
Automatic Satellite Dish*	O	O	O	O	O
Prewired for Winegard Traveler Satellite (NA with In-motion or Automatic Satellite)	O	O	O	O	O
Exterior 32" TV	O	O	O	O	O
8.0 kw Onan® Manual Slide-out Generator	S	S	S	S	NA
10.0 kw Onan® Manual Slide-out Generator	NA	NA	NA	NA	S
Two 15,000 BTU Low Profile Roof AC with Heat Pumps	S	S	S	S	NA
Three Low Profile Roof AC with Heat Pumps & 10.0 kw Onan® Generator	NA	O	O	O	S

*High-definition programming is not available on a domed satellite antenna unless you subscribe to DISH Network®.

Cockpit

STANDARD ON ALL MODELS:

- Power Ultra Leather Driver & Passenger Seats with Passenger Footrest
- Contemporary Wraparound Dash with Glare Reduction
- Courtesy Light & Drawer in Step Well
- Dual Dash Fans
- Snack/Beverage Tray with Drawers
- Dual 12 V Dash Receptacle
- Single CD Player & AM/FM Stereo
- Fire Extinguisher
- Computer Drawer on Passenger Side with Lock-out Rails
- Power Solar/Privacy Windshield Shade
- Driver/Passenger Side Window Solar/Privacy Shades
- Color Rear Vision Monitor System with Side-view Cameras Activated by Turn Signals
- Adjustable Seatbelt Brackets
- Custom Infrared Repeater System

AVAILABLE OPTIONS:	36 QSH	40 QBH	40 QKH	40 QTH	42 QBH
Satellite-ready Radio (Requires Subscription)	O	O	O	O	O
37" Front Overhead TV	O	O	O	O	O
In-dash Stereo/Navigational System	O	O	O	O	O

Living Area/Dinette

STANDARD ON ALL MODELS:

- Booth Dinette with Laminate Tabletop & Solid Surface Edging
- 42" Midsection TV in Entertainment Center
- Ultra Leather DE Sofa/Sleeper on Passenger Side
- Cloth DE Sofa/Sleeper on Driver Side

AVAILABLE OPTIONS:	36 QSH	40 QBH	40 QKH	40 QTH	42 QBH
Freestanding Dinette with Built-in Cabinets	O	O	O	O	O
Freestanding Dinette with Computer Workstation	O	O	O	O	O
Ultra Leather U-shaped Booth Dinette	O	O	O	O	O
Cloth U-shaped Booth Dinette	O	O	O	O	O
Cloth DE Sofa/Sleeper on Passenger Side	O	O	O	O	O
Ultra Leather Air Coil Hide-A-Bed Sofa/Sleeper on Passenger Side	NA	O	O	O	O
Cloth Air Coil Hide-A-Bed Sofa/Sleeper on Passenger Side	NA	O	O	O	O
Ultra Leather DE Sofa/Sleeper on Driver Side	O	O	O	O	O
Ultra Leather Air Coil Hide-A-Bed Sofa/Sleeper on Driver Side	O	NA	NA	NA	NA
Cloth Air Coil Hide-A-Bed Sofa/Sleeper on Driver Side	O	NA	NA	NA	NA
Ultra Leather Magic Bed on Driver Side	O	O	O	O	O
Cloth Magic Bed on Driver Side	O	O	O	O	O
Two Leather Lift Recliners on Driver Side	NA	O	O	O	O
Entertainment Center with One Leather Lift Recliner & Flip Table on Driver Side	NA	O	O	O	O
Fireplace Below TV	NA	O	O	O	O

Specifications

Kitchen

STANDARD EQUIPMENT ON ALL MODELS:

- Solid Surface Countertop with Stainless Steel Sink
- Solid Surface Sink Cover
- Expand-an-island
- Permanent Mounted Folding Solid Surface Cooktop Cover
- Sink Cover Storage Racks Underneath Sink
- Single Lever Sink Faucet with Sprayer
- Convection Microwave with Exterior Venting
- Galley Splash Guards
- Residential Stainless Steel Refrigerator with Icemaker in Freezer (6 Batteries)
- 3-burner Cooktop
- Built-in Soap Dispenser
- Built-in Waste Can

AVAILABLE OPTIONS:	36 QSH	40 QBH	40 QKH	40 QTH	42 QBH
4-Door Gas/Electric Fridge with 4 Batteries	O	O	O	O	O
Gas Oven	O	O	O	O	O

Bath

STANDARD EQUIPMENT ON ALL MODELS:

- Medicine Cabinet with Vanity Lights
- Skylight in Shower with Sliding Cover
- Solid Surface Vanity Top & Bowl
- Custom Flat Panel Bath Door
- One-piece Fiberglass Shower Surround
- 10-Gallon DSI Gas/Electric Water Heater
- Glass Shower Door
- 3-speed Fantastic® Fan
- Hand-held Shower Head with On/Off Switch
- Spray Cleaner on Toilet

AVAILABLE OPTIONS:	36 QSH	40 QBH	40 QKH	40 QTH	42 QBH
41" Molded Fiberglass Shower	S	NA	NA	NA	NA
36" Molded Fiberglass Shower with Radius Door	NA	S	S	S	S
Tub (in Place of Shower)	NA	NA	O	NA	NA
Tankless Gas Water Heater	O	O	O	O	O

Bedroom

STANDARD EQUIPMENT ON ALL MODELS:

- Wardrobe with Automatic Light
- Bed Comforter with Throw Pillows
- Prepared for DVD & Satellite Receiver
- Under Bed Storage
- Pillow Top Mattress
- Ceiling Fan
- 32" TV
- Carbon Monoxide Detector
- Wood/Fabric Headboard
- LPG Leak Detector
- Chest of Drawers with Laundry Hamper
- Wall-to-wall Carpet

AVAILABLE OPTIONS:	36 QSH	40 QBH	40 QKH	40 QTH	42 QBH
Bunk Beds with Bunk Ladder/Convertible Wardrobe	NA	NA	S	NA	NA
DVD Monitors in Bunk Beds	NA	NA	O	NA	NA
King Bed Mattress (72" x 80")	NA	O	O	O	O
Dual Control Bed System—Queen (60" x 80")	O	O	O	O	O
Dual Control Bed System—King (72" x 80")	NA	O	O	O	O
Memory Foam Queen Mattress (60" x 80")	O	O	O	O	O
Memory Foam King Mattress (72" x 80")	NA	O	O	O	O
Tile Flooring in Bedroom	O	NA	NA	NA	O

Interior

STANDARD EQUIPMENT ON ALL MODELS:

- 7' Ceilings
- Soft Touch Vinyl Ceiling with Tray Ceiling in Living Area
- Porcelain Tile Floor in Kitchen, Living Area, Bath & Entry Landing
- Carpeting in Bedroom & Driver Compartment with Scotchgard®
- High Gloss Raised Panel Hardwood Cabinet Doors
- Two Ducted Furnaces (One 30,000 BTU & One 35,000 BTU)
- Solid Wood Cabinet Facias with Concealed Hinges
- Complete Cable Wiring Interfacing with Surround Sound & Satellite Receiver
- Home Theater Sound System with Concealed Speakers
- Solar/Privacy RollEase® Shades
- LED Bulbs in Ceiling Lights Only
- Fantastic® Power Roof Vents with 3-speed Fans
- Tank Level Monitor System
- Smoke Detector
- Air Driven Step Well Cover
- 12 V Disconnect Switch

AVAILABLE OPTIONS:	36 QSH	40 QBH	40 QKH	40 QTH	42 QBH
Medium Alderwood Solid Cabinet Doors & Drawer Fronts	O	O	O	O	O
English Chestnut Solid Cabinet Doors & Drawer Fronts	O	O	O	O	O
Cherry Bark Solid Cabinet Doors & Drawer Fronts	O	O	O	O	O
Combo Washer/Dryer	O	O	O	O	O
Stacked Washer/Dryer	O	O	O	O	O
Central Vacuum Cleaner	O	O	O	O	O

Structural/Construction

STANDARD ON ALL MODELS:

• Laminated Floor, Sidewall & Roof

• Steel/Aluminum Reinforced Structure

• One-piece Molded Fiberglass Roof Cap

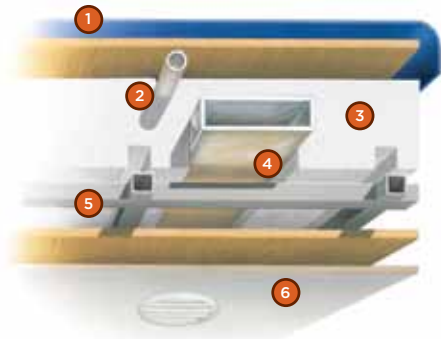

Roof

- 1 One-piece, moisture resistant molded fiberglass roof cap provides insulation and strength and prevents water intrusion
- 2 A/C Condensation Drainage System that runs internally through the roof insulation and down the sidewalls, redirecting water underneath the motor home
- 3 5 1/2" formed insulation
- 4 Quiet Air Cooling System with return air and foil-wrapped cooling exhaust ducts
- 5 Durable, tubular aluminum roof skeleton
- 6 Easy-to-clean soft touch vinyl ceiling panel

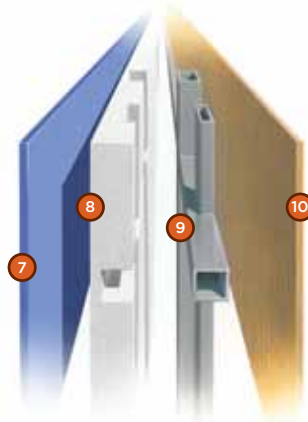

Sidewall*

- 7 Gel-coat fiberglass outside wall panel
- 8 High-performance thermal insulation
- 9 Durable, yet lightweight, tubular aluminum wall skeleton
- 10 Decorative inside wall panel

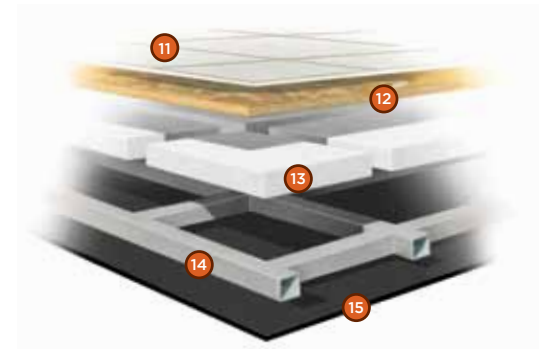

Floor

- 11 Porcelain tile floor bonded to high-impact oriented strand board
- 12 High-level engineered oriented strand board
- 13 High-performance thermal insulation
- 14 Durable, tubular floor skeleton
- 15 Woven moisture barrier material

*All sidewalls are approximately 2" thick.

All options may not be available in every model. Because of progressive improvements, specifications, standard & optional equipment are subject to change without notice or obligation. For a complete and up-to-date list of available options and specifications, visit tiffinmotorhomes.com

Why buy a Tiffin Motorhome?

Every company under the sun talks about quality. For some, that's all it is—talk. Unlike our competitors, Tiffin Motorhomes produces many of our own parts. Not only does this give us complete control over quality, it enables us to later provide replacement parts for older models. That means, on a Tiffin coach, Tiffin craftsmen also manufactured the windows, moldings, fiberglass, textiles, finishes, millwork, custom cabinetry, and, on some models, the chassis. Building the best motor homes in the industry is our goal, and keeping a close eye on quality is always one way you can count on us to deliver.

10-YEAR LIMITED FRAME WARRANTY

We warranty the frame of the walls, floors, and roof for 10 years.

5-YEAR LIMITED SIDEWALL BOND WARRANTY

We warranty the sidewall against delamination between the outside fiberglass and the inner frame for 5 years.

tiffinmotorhomes.com

Visit us on the web for more information on the 2012 Phaeton and all of our 2012 Tiffin Motorhomes, as well as the latest product and specification updates. Plus, watch videos and see other exclusive web content.

FOR PARTS & SERVICE CALL 256/356.0261

YOUR LOCAL TIFFIN DEALER:

TIFFIN MOTORHOMES



This year, Tiffin Motorhomes proudly celebrates our 40th year of building the finest motor homes on the road. What an amazing ride we've had—and are still having. Thanks to everyone who has been a part of our journey, from our dedicated team to our wonderful customers. We sure couldn't have done it without you. Fasten your seatbelts, everybody, and let's get going to make it another 40 years!

Safe travels,

Bob Tiffin

President/Founder

40 Years
TIFFIN MOTORHOMES
WHEREVER YOU GO, WE GO.
1972 / 2012

SOME INTERIOR FURNISHINGS NOT INCLUDED. UNLESS WHERE NOTED, ALL CONTENT ©2011 TIFFIN MOTORHOMES, INC. ALLEGRO®, ALLEGRO BREEZE®, ALLEGRO RED®, PHAETON®, ALLEGRO BUS®, ZEPHYR®, ROUGHING IT SMOOTHLY®, OPEN ROAD®, POWERGLIDE®, AND PUSHER® ARE REGISTERED TRADEMARKS OF TIFFIN MOTORHOMES, INC. ALL RIGHTS RESERVED.

105 2ND STREET NW, RED BAY, ALABAMA 35582
CALL 256/356.8661 FAX 256/356.8219

